

RADIO'S LIVEST MAGAZINE



November
25 Cents

Radio-Craft

for the
Professional-Serviceman-Radiotrician

HUGO GERNSBACK Editor



Radio-Photo Eye

Opens Door

Automatically

See Page 280

Novel Applications for Radio. The
Newest Radio Receivers. Auto-
motive Radio-Sound Installation.
Short Waves--Television

Unconventional Voltage Distribution
By John F. Rider
Service Men's Notes

Automatic Volume Control
for Your Receiver
By C. W. H. Nason
The Radio Craftsman

OPPORTUNITY

IS KNOCKING AT YOUR DOOR

RIGHT NOW
 from this GREAT FIELD of
RADIO
 TELEVISION
 TALKING PICTURES

BIG MONEY STEADY JOBS OFFERED and the Definite Way to Get Them

Good Jobs at Good Pay! Steady, Interesting Work! Fine Profits for your Spare Hours! Big Money as Your Own Boss! That's the Opportunity for you in Radio right Now! Why? Because the great, fast-growing Radio industry has reached the stage where it must have many more trained men. Most of those now employed are untrained—they just "picked up" what they know about radio, and even many of them get good pay. But the *Big Pay Steady* jobs go to the *Trained Man*, and R. T. I. offers you the definite way to prepare for them. R. T. I. training is endorsed by Leading Radio Men and Radio Trade Associations.

R. T. I. TRAINS YOU AT HOME FOR THE BETTER PAID RADIO JOBS

Do you want to get into some branch of Radio where trained men can easily make \$40 to \$50 weekly—where some earn \$75 to \$100 per week—where trained experienced men are selected for executive positions paying up to \$5,000 and \$10,000 yearly and more? Then send for the R. T. I. Radio Opportunity Book. Find out how R. T. I. trains you at home for this well-paid work—you don't have to give up your present job—you learn quickly and thoroughly—just a little time needed at home—earn an extra \$10 to \$20 per week in spare hours while learning—Then step into radio and go steadily on up to the Big Money. No experience needed to start—R. T. I. starts you right.

LEARN TELEVISION— and Talking Pictures, TOO

Be prepared for Television! Learn Talking Picture Apparatus installation, adjustment, etc.! Both of these great branches of Radio are included in the R. T. I. practical training.

LEARN FROM LEADERS

Why does the radio industry want men trained the R. T. I. way? Because you learn under experts—leading men in different branches of Radio—well known specialists of high standing.

FREE OPPORTUNITY BOOK

Remember, you need no experience to start in Radio—R. T. I. starts you right—and helps you on to success. The big R. T. I. Radio Opportunity book explains everything. If you are interested, send for it now. Don't wait.

Use the coupon, or write, or telegraph to
RADIO AND TELEVISION INSTITUTE
 Dept. 768, 4806 St. Anthony Court, Chicago, Ill.

RADIO & TELEVISION INSTITUTE
 4806 St. Anthony Court, Chicago, Dept. 768

Send me Free and prepaid your **BIG RADIO OPPORTUNITY BOOK**, "Tune In On Big Pay," and full details of your three-in-one Home Training (without obligating me in any way).

Name _____
 Address _____
 City _____ State _____

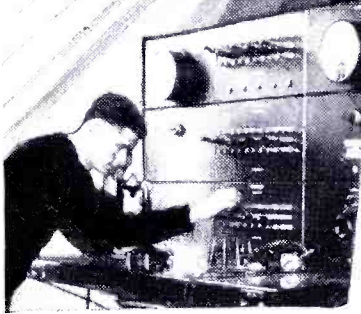
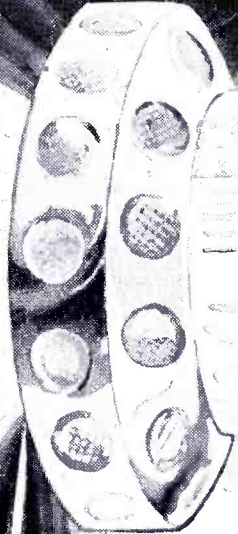

BROADCASTING
 Stations demand better trained men

SERVICE
 Where R. T. I. training brings quick money.

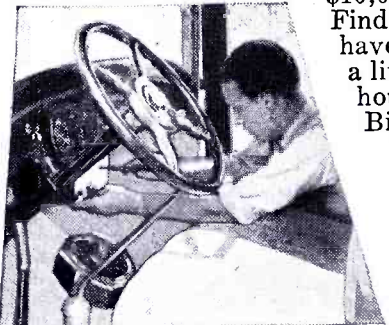
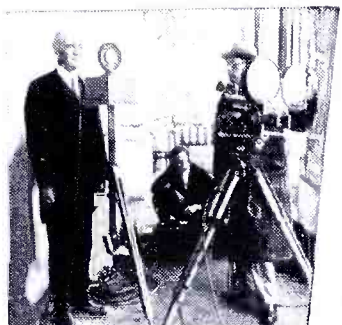

TALKIES
 Studio and theatre apparatus requires trained men.

AUTO-RADIO
 Great field for men with R. T. I. training.

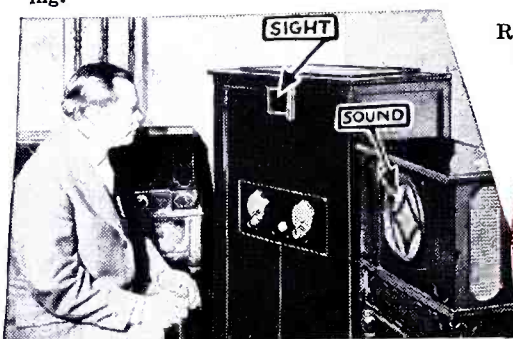
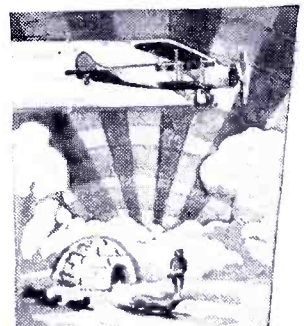

AVIATION
 Trained radio men needed more and more.

TELEVISION
 Great new branch of radio soon to call for many trained men.

R. T. I. Home Training includes all these and the other branches of Radio. You learn under F. H. Schnell, "The Ace of Radio," and the R. T. I. Advisory Board of prominent radio men.

R. T. I. R. T. I. TRAINS YOU AT HOME FOR A GOOD JOB OR A PROFITABLE PART TIME OR FULL TIME BUSINESS OF YOUR OWN





We Could Have Placed 5000 More Qualified Men Last Year in Good Pay RADIO Positions

GET into the rich field of Radio via the training school that supplies big Radio employers with their new men! The Radio Training Association of America has a standing order from radio trade organizations, large manufacturers and dealers, for members qualified for full time work at splendid pay.

So great is this demand from Radio employers that positions offering good pay and real opportunity are going begging. If you want to cash in on Radio quick, earn \$3.00 an hour and up spare time, \$40 to \$100 a week full time, prepare for a \$10,000, \$15,000, \$25,000 a year Radio position, investigate the R. T. A. now.

Special Attention to Radio Service Work

Thousands of trained Radio Service Men are needed now to service the new all-electric sets. Pay is liberal, promotions rapid. The experience you receive fits you for the biggest jobs in Radio. The R. T. A. has arranged its course to enable you to cash in on this work within 30 days!

Would you like to work "behind the scenes" at Hollywood, or for a talking picture manufacturer? R. T. A. training qualifies you for this work. Television, too, is included in the training. When television begins to sweep over the country, R. T. A. men will be ready to cash in on the big pay jobs that will be created.

**Expert Supervision
Lifelong Consultation Service**

As a member of the Association you will receive personal instruction from skilled Radio Engineers. Under their friendly guidance every phase of Radio will become an open book to you. And after you graduate the R. T. A. Advisory Board will give you personal advice on any problems which arise in your work. This Board is made up of big men in the industry who are helping constantly to push R. T. A. men to the top.

Because R. T. A. training is complete, up-to-date, practical, it has won the admiration of the Radio industry. That's why our members are in such demand—why you will find enrolling in R. T. A. the quickest, most profitable route to Radio.

Mail Coupon for No-Cost Training Offer

Memberships that need not—should not—cost you a cent are available for a limited time. The minute it takes to fill out coupon at right for details can result in your doubling and trebling your income in a few months from now. If you are ambitious, really want to get somewhere in life, you owe it to yourself to investigate. Learn what the R. T. A. has done for thousands—and can do for you. Stop wishing and start *actually doing something* about earning more money. Fill out the coupon and mail today.

**Radio Training Association of America
Dept. RCA-11 4513 Ravenswood Ave., Chicago, Ill.**

Fill Out and Mail Today!

RADIO TRAINING ASSOCIATION OF AMERICA
Dept. RCA-11 4513 Ravenswood Ave., Chicago, Ill.
Gentlemen: Send me details of your No-Cost Training Offer and information on how to make real money in Radio quick.

Name _____

Address _____

City _____ State _____

H. GERNSBACK, President
 S. GERNSBACK, Treasurer
 J. M. HERZBERG, Vice-President
 I. S. MANHEIMER, Secretary

R. D. WASHBURNE,
 Technical Editor



HUGO GERNSBACK, Editor-in-Chief

JOHN F. RIDER,
 Editor Service Dept.

C. P. MASON,
 Associate Editor

VOLUME II
 NUMBER 5

Contents of This Issue

NOVEMBER
 1930

	PAGE		PAGE
EDITORIAL:			
Television is Coming.....	263	Television Projected in Three Dimensions.....	277
By Hugo Gernsback		A New Self-Contained Television Reproducer	
		By George Wald	277
SERVICE MEN'S DEPARTMENT:			
Unconventional Voltage Distribution..	264	The New "Times Square" Studio of the N. B. C.	
Leaves from Service Men's Notebooks		By C. A. Rackey and R. M. Morris	278
By RADIO-CRAFT Readers		265	
Operating Notes for Service Men..	267	New Applications of Radio Principles.....	280
The Flying Service Man.....		By R. Douglas Clerk	267
RADIO SERVICE DATA SHEETS:			
Radiola-Victor "R80"—Westinghouse "WR5"—Gray-			
bar "700"—General Electric "H-31".....	268		
Grebe A.C. Super-Synchrophase "SK-4".....	269		
The Business End of Radio Servicing			
By George K. Graham		270	
Servicing the Brunswick "S14" and "S21"			
By Harold Weiler		272	
Modernizing Old Sets:			
The Radiola "18 D.C.".....	273		
By Alex. Vergas		273	
The Radiola "AR-812,".....	273	SHORT-WAVE CRAFT:	
By Ralph W. Luce		273	
NEW DEVELOPMENTS IN RADIO:			
And Now—The "Midget" Radio Set.....	274	The "Radiola 28" at 80 Meters.....	282
A Versatile Unit for All Radio Purposes.....	275	The How and Why of the Short-Wave Super	
The Development of the Screen-Grid Super		By L. W. Hatry	
		283	
By W. H. Hollister		276	284
CONSTRUCTIONAL AND EXPERIMENTAL:			
The Car Battery for Automotive Radio			
By Solomon Perlman		285	
Mounting the Loud Speaker for Automotive Radio			
By Yates M. Hoag		285	
A "Roll Your Own" Superheterodyne.....		By W. E. Smith	
286		287	
Automatic Volume-Control Design			
By C. H. W. Nason		287	
The Screen-Grid "Better Booster".....		By E. F. Henning	
288		288	
More Power for the Sound Installation			
By Ludwig Arnson		289	
RADIO-CRAFT's Information Bureau.....		290	
The Radio Craftsman's Own Page.....		293	

In Forthcoming Issues

MAKING YOUR OWN PHONOGRAPH RECORDS. The newest turn in radio is to use the audio equipment, not merely for reproduction of records, but for the production of them. The home-made record, cut in the old mechanical way, was unsatisfactory; but the power of the radio receiver may be applied to electrical reproduction in the same manner that modern discs are now produced. This article will be of interest to all who are looking for something really new to do with radio.

NEW DEVELOPMENTS IN RADIO. The Radio World's Fair will usher in the 1930-31 season, and will present novelties of especial interest to the Service Man as well as the

radio fan. RADIO-CRAFT will deal with the newest commercial devices from the practical standpoint.

NEW TELEVISION SYSTEMS. Activity in these lines is steadily progressing. Television receivers are coming closer and closer to the commercial stage, and the mechanical and radio difficulties are steadily being smoothed away. RADIO-CRAFT will continue to keep its readers in touch with every step in advance that is made.

BUILDING A DIRECT-COUPLED AMPLIFIER. A constructional article dealing with the design and assembly of a '45-type unit which will give high quality, and ample volume for the home.

RADIO-CRAFT is published monthly, on the fifth of the month preceding that of date; its subscription price is \$2.50 per year. (In Canada and foreign countries, \$3.00 a year to cover additional postage.) Entered at the postoffice at Mt. Morris, Ill., as second-class matter under the act of March 3, 1879. Trademarks and copyrights by permission of Gernsback Publications, Inc., 98 Park Place, New York City.

Text and illustrations of this magazine are copyright and must not be reproduced without permission of the copyright owners. We are also agents for WONDER STORIES, AMAZING DETECTIVE TALES and WONDER STORIES QUARTERLY. Subscriptions to these magazines may be taken in combination with RADIO-CRAFT at reduced Club rates. Write for information.

Copyright 1930, GERNSBACK PUBLICATIONS, INC.

Published by
TECHNI-CRAFT PUBLISHING CORPORATION

Publication Office: 404 No. Wesley Ave., Mount Morris, Illinois

Editorial and Advertising Offices
 96-98 Park Place, New York City

Western Advertising Office
 737 North Michigan Avenue, Chicago, Ill.

L. F. McCLURE, Western Advertising Representative

London Agent: Hachette & Co.,
 6-17 King William St., Charing Cross, W.C. 2

Paris Agent: Hachette & Co.,
 111 Rue Reaumur

Australian Agent: McGill's Agency,
 179 Elizabeth St., Melbourne

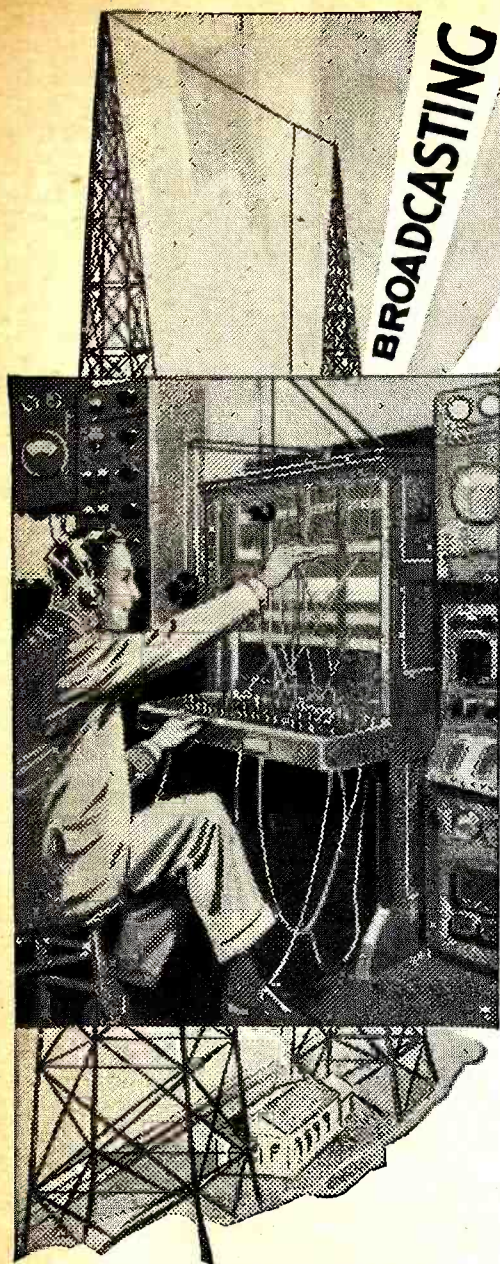

BROADCASTING

TELEVISION

TALKING PICTURES

WIRELESS OPERATING

WIN FAME and FORTUNE in RADIO!

Don't spend your life slaving away in some dull, hopeless job! Don't be satisfied to work for a mere \$20 or \$30 a week. Let me show you how to make real money in Radio—the fastest-growing, biggest money-making game on earth!

THOUSANDS OF JOBS ARE OPEN
Paying \$60, \$70 and on up to \$200 a Week

Jobs as Designer, Inspector and Tester, paying \$3,000 to \$10,000 a year—as Radio Salesman and in Service and Installation Work, at \$45 to \$100 a week—as Operator or Manager of a Broadcasting Station, at \$1,800 to \$5,000 a year—as Wireless Operator on a Ship or Airplane, as a Talking Picture or Sound Expert—THOUSANDS of JOBS Paying \$60, \$70 and on up to \$200 a WEEK!

Learn Without Lessons *in* 60 Days

You learn ALL branches of Radio at Coyne—in 8 short, pleasant weeks—NOT BY CORRESPONDENCE, but by actual work on actual Radio, Television and Sound equipment. We don't waste time on useless theory. We give you just the practical training you will need—in 8 weeks' time.

No Books - No Lessons
All Practical Work at Coyne

Coyne is NOT a Correspondence School. We don't teach you from books or lessons. We train you on the greatest outlay of Radio, Television and Sound equipment in any school—on scores of modern Radio Receivers, huge Broadcasting equip-

ment, the very latest Television apparatus, Talking Picture and Sound Reproduction equipment, Code Practice equipment, etc. You don't need advanced education or previous experience. We give you—right here in the Coyne Shops—all the actual practice and experience you'll need.

TELEVISION Is on the Way!

And now Television is on the way! Soon there'll be a demand for THOUSANDS of TELEVISION EXPERTS! The man who learns Television NOW can make a FORTUNE in this great new field. Get in on the ground-floor of this amazing new Radio development! Learn Television at COYNE on the very latest, newest Television equipment.

Talking Pictures A Great Field

Talking Pictures and Public Address Systems offer thousands of golden

opportunities to the Trained Radio man. Here is a great new field of Radio that has just started to grow! Prepare NOW for these marvelous opportunities! Learn Radio Sound Work at Coyne, on actual Talking Picture and Sound Reproduction equipment.

Coyne is 31 Years Old

Don't worry about a job! Coyne Training settles the job question for life. You get Free Employment Help as long as you live. And if you need part-time work while at school to help pay expenses we'll gladly help you get it. Coyne is 31 years old! Coyne Training is tested—proven beyond all doubt. You can find out everything ABSOLUTELY FREE. JUST MAIL COUPON FOR MY BIG FREE BOOK.

H. C. Lewis, Pres. **Radio Division** Founded 1899
Coyne Electrical School
 500 S. Paulina Street Dept. 80-7C Chicago, Illinois

H. C. LEWIS, President
 Radio Division, Coyne Electrical School
 500 S. Paulina St., Dept. 80-7C Chicago, Ill.

Send me your Big Free Radio Book and all details of your Special Introductory Offer. This does not obligate me in any way.

Name

Address

City State

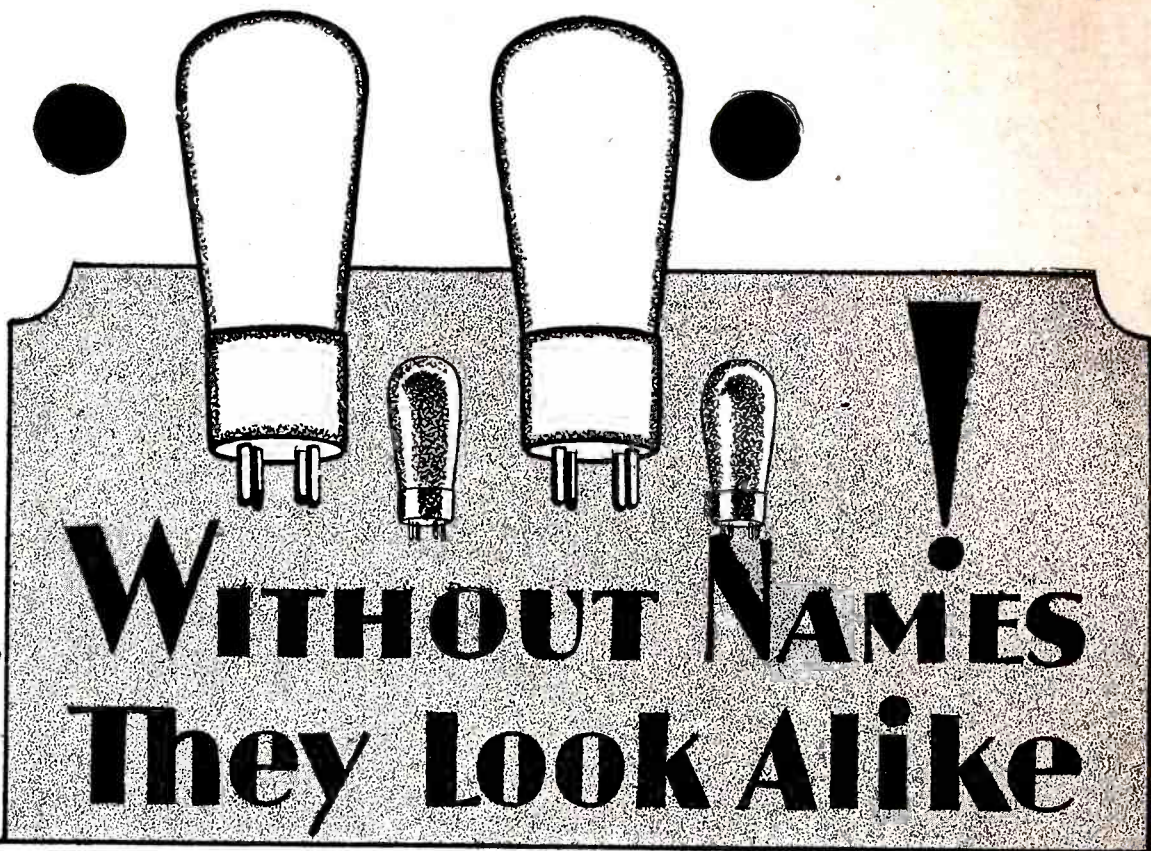
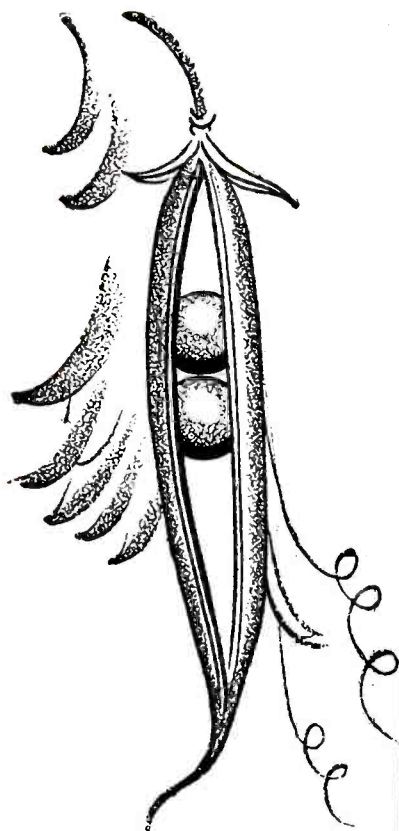

RADIO tubes look alike outside and inside. But what a difference when it comes to performance. There are reasons — and plenty of them — why Professionals endorse Pilotron Radio Tubes. If you could test your tubes as the scientist does, you would quickly agree that Pilotron Radio Tubes are to be preferred...dependable under all conditions — quick to get into action — perfect in tone reproduction — uniform in quality. Even though Pilotrons are better, they cost no more than ordinary tubes. Your Pilot radio dealer will gladly explain more fully why you should prefer Pilotrons.

ENDORSED BY PROFESSIONALS

PILOTRON
LICENSED BY R. C. A.
RADIO TUBES

PILOT RADIO & TUBE CORP.

Chicago Office:
 234 S. Wells Street

LAWRENCE, MASS.

San Francisco Office:
 1278 Mission Street

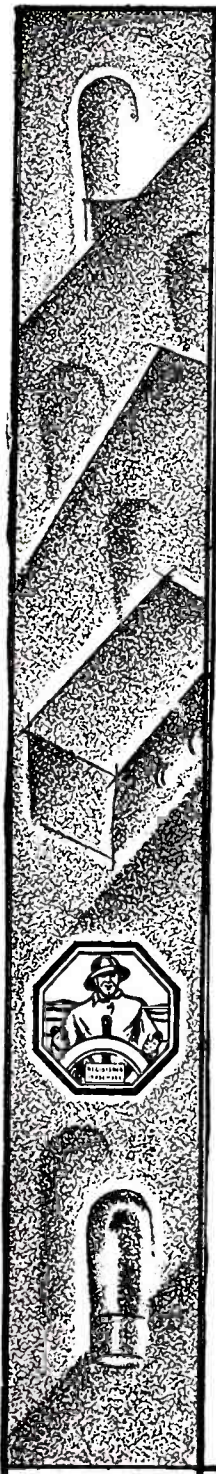

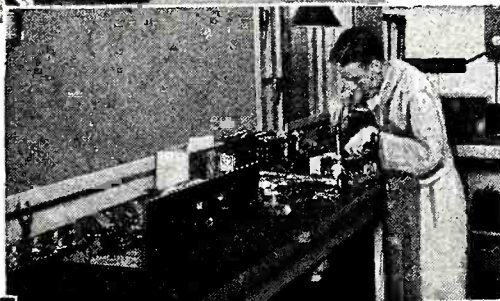
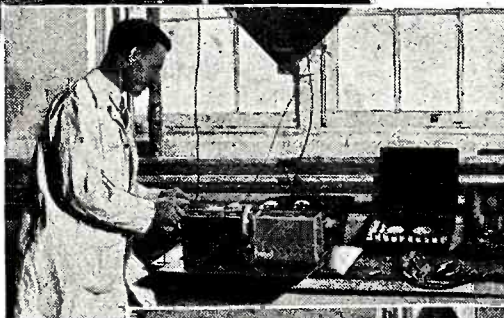
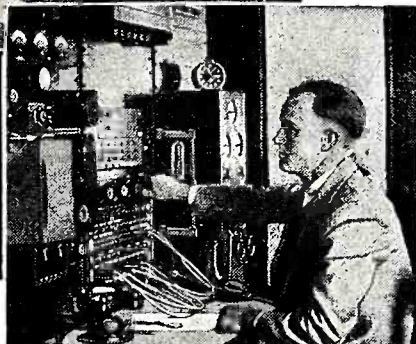
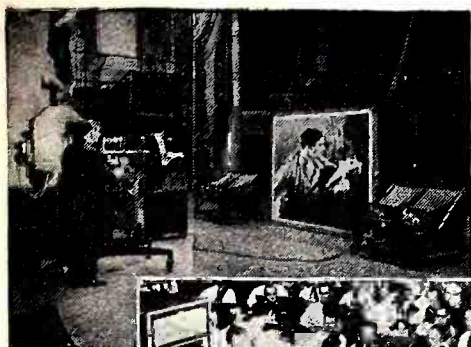

The One Sure Way to BIG PAY in RADIO

Send for my Free Book See how Quickly I Train You at Home to Fill a Big-Pay Radio Job

In Radio more than in any other field, the surest, quickest way to get ahead is through *training!* For Radio is in crying need of more well-trained men. Competition is keen among the untrained fellows but the way is wide open for men who *know* Radio! Moreover, there are plenty of opportunities to earn while you learn—many of my students make \$200 to \$1000 in their spare time while learning. That is why I urge you to mail the coupon below for my free book. It tells about the great money-making opportunities that Radio offers trained men—and how you can learn at home to become a Radio Expert.

Many Earn \$50 to \$100 a Week

Many of my graduates are earning \$50 to \$100 a week. After completing my training you, too, should earn as good or even better pay. Hundreds of fine jobs are opening every year. Broadcasting Stations pay \$1,800 to \$5,000 a year to Radio engineers, operators, and station managers. Radio manufacturers continually need testers, inspectors, foremen, engineers, service men, buyers, for jobs paying up to \$15,000 a year. Shipping companies use hundreds of operators, giving them good pay plus expenses. Radio dealers and jobbers pay \$30 to \$100 a week to trained service men, salesmen, buyers, managers. Talking Movies pay as much as \$75 to \$200 a week to men with Radio training. Another way to make big money is to open a spare time or full time Radio sales and service business of your own. And any day now Television may open the way to a new world of opportunities to men who *know* Radio.

My Free Book Tells All

Get the whole story. Send for my 64-page book of facts on the many opportunities for trained men in Radio today. It has put hundreds of fellows on the road to bigger pay and success. It also contains full information on the "Eighteen Star Features" of my home-study training, including Lifetime Employment Service to graduates. I back my course with a signed agreement to refund every penny of your money if, after completion, you are not satisfied with the Lessons and Instruction Service I give you. **Don't let lack of complete training keep you down. Fill in and mail the coupon NOW!**

YOU MUST HAVE NRI TRAINING to be a CERTIFIED RADIO-TRICIAN

My course is the **ONLY** one that makes you a "Certified RADIO-TRICIAN." The U. S. Government grants me *exclusive* right to give that distinctive title to all who complete my training. It will mean valuable recognition to you in whatever branch of Radio you follow and will help open the door to bigger pay. Even before you graduate I give you business cards and a "JUNIOR RADIO-TRICIAN" card, which many of my students find helpful in earning money in spare time. My course has helped hundreds of men. It will help you. Send for my free book and you'll see why.

Seldom Under \$100 a Week



"Dear Mr. Smith: For the month of November I made \$577 and for December over \$645, and January, \$465. My earnings seldom fall under \$100 a week. I'll say the N. R. I. (National

Radio Institute) course is thorough and complete. — letter from graduate, E. E. Winborne, 1414 W. 48th Street, Norfolk, Va.

Unlimited Consultation Service

You can keep yourself posted on new developments without extra cost. Radio's change and growth bring new opportunities for the man who understands them. You'll have our whole Staff at your service to keep you informed.



J.E. Smith, Pres., NATIONAL RADIO INSTITUTE Dept. OMY, WASHINGTON D. C.

FREE 64 page BOOK



Mail Coupon Today

J. E. SMITH, President National Radio Institute, Dept. OMY, Washington, D. C.

Dear Mr. Smith: Send me your free book. I want to know exactly what Radio offers trained men—and what you offer in home-study Radio training. I understand this places me under no obligation and that no salesman will call.

Name.....
Address.....
City.....State.....

Announcement!



NATIONAL RADIO SERVICE MEN'S ASSOCIATION

BOARD OF DIRECTORS

L. M. Cockaday

David Grimes

John F. Rider

Hugo Gernsback

Sidney Gernsback

I. S. Manheimer

EVER since the appearance of the commercial radio broadcast receiver as a household necessity, the Radio Service Man has been an essential factor in the radio trade; and, as the complexity of electrical and mechanical design in receivers increases, an ever-higher standard of qualifications in the Service Man becomes necessary.

The necessity, also, of a strong association of the technically-qualified radio Service Men of the country is forcing itself upon all who are familiar with radio trade problems; and their repeated urgings that such an association must be formed has led us to undertake the work of its organization.

This is the fundamental purpose of the NATIONAL RADIO SERVICE MEN'S ASSOCIATION, which is not a money-making institution, or organized for private profit; to unite, as a group with strong common interests, all well-qualified Radio Service Men; to make it readily possible for them to obtain the technical information required by them in keeping up with the demands of their profession; and, above all, to give them a recognized standing in that profession, and acknowledged as such by radio manufacturers, distributors and dealers.

To give Service Men such a standing, it is obviously necessary that they must prove themselves entitled to it; any Service Man who can pass the examination necessary to demonstrate his qualifications will be elected as a member and a card will be issued to him under the seal of this Association, which will attest his ability and prove his identity.

The terms of the examination are being drawn up in co-operation with a group of the best-known radio manufacturers, as well as the foremost radio educational institutions.

The following firms are co-operating with us:
GRIGSBY-GRUNOW CO (Majestic), CHICAGO
STROMBERG-CARLSON TELEPHONE MFG. CO., ROCHESTER, N. Y.
CROSLY RADIO CORP., CINCINNATI, OHIO
COLIN B. KENNEDY CORP., SOUTH BEND, IND.

The schools who have consented to act as an examination board are:
International Correspondence Schools, Scranton, Penna.; Mr. D. E. Carpenter, Dean.
RCA Institutes, Inc., New York, N. Y.; Mr. R. L. Duncan, President.
Radio & Television Institute, Inc., Chicago, Ill.; Mr. F. G. Wellman, Managing Director.
Radio Training Association of America, Chicago, Ill.; Mr. A. G. Mohaupt, President.
School of Engineering of Milwaukee, Milwaukee, Wisc.; Mr. W. Werwath, President.
Rider-Goll Radio School, New York, N. Y.; Mr. John F. Rider, Director.
Radio College of Canada, Toronto, Canada; Mr. J. C. Wilson, President.
Radio Division, Coyne Electrical School, Chicago, Ill.; Mr. H. C. Lewis, President.

We shall not attempt to grade the members into different classes. A candidate will be adjudged as either passing or not passing. If the school examining the papers passes the prospective member as satisfactory, we shall issue to him an identification card with his photograph.

If the candidate does not pass this examination the first time, he may apply for another examination three or six months later.

There is absolutely no cost attached to any service rendered by the Association to its members, no dues, no contributions.

If you wish to become a member, just fill out the coupon below and mail it to us. We will send you all the papers necessary to become a member.

N. R. S. M. A.,
c/o RADIO CRAFT,
98 Park Place,
New York, N. Y.

I wish to become a member of your Association. Please mail be the examination papers and application blanks.

Name
Address
Town..... State.....



"Takes the Resistance Out of Radio"

Editorial Offices, 96-98 Park Place, New York, N. Y.

Television is Coming

By Hugo Gernsback

FOR many years, television has been shouted from the housetops. Perhaps no one was more emphatic in the shouting than the present writer. Indeed, it was through his efforts that the first public television broadcast in New York City was given through his former broadcast station, WRNY, on August 12, 1928.

The writer has steadfastly stuck to the belief that, sooner or later, television for the home will arrive, and that, when it does, it will certainly rival the radio broadcasting of sound programs as a means of entertainment. This hope seems now on the eve of its fulfillment. Of course, television has been with us for some years, even out of the laboratory stage; and such stations as that of Jenkins in Jersey City have been broadcasting for some time. But the great boom, which we all hope will soon flourish when the public will take television to its heart as it has taken radio to its heart, is still in the near future, though not too far distant. Sooner or later it will arrive with a bang. As soon as our various radio companies are ready to put out television receivers, the writer predicts a boom far in excess of the 1922-23 radio boom.

At the present time, of course, there are a number of stations already broadcasting television; as the list on this page shows.

The radio commission is being asked daily for television broadcast licenses; and any number of such applications are on file today, with a number having been granted already.

The National Broadcasting Corporation, it is understood, is even now planning to stage television programs in its new studio at 42nd Street and Broadway, New York City (a description of which appears in this issue.)

All of these are important signs of the times, so far as television is concerned, and will all help to give the new industry its final push towards popularity.

Of course, our big radio corporations do not wish to be

caught napping as they were in 1922; and they do not plan to come out and sell only the parts, so that the man who will wish to build his own television set may do so.

Too many radio firms think today that the better way is to put out a complete set, completely self-contained; wherein a switch turns on not only the radio broadcast of sound but radio television as well. As the art is practised at present, you require two wavelengths to do this; one to broadcast the

oral part of the program and then the short wavelength to broadcast the television impulses. A set which combines the two can be easily visualized, and the time will come when a single control will take care of both sound and vision.

That time, of course, is not here as yet; but the writer does not believe, as he has often mentioned before, that the present-day disc with its motor will prevail till the end in the television art. The mechanical scanning apparatus is not the solution of television. It is the electronic tube that will finally solve the problem; and, when this happens, the experimenter and the man who builds his own will again come to the front.

Television, the writer believes, will take the course followed by radio sound broadcasts. Hundreds of different firms will be making the various parts for television; and the experimenter and builder will again make his own television set, for reasons which should be quite obvious.

In the first place, people are now investing quite a good deal of money in expensive radio receiving sets. It is not likely that the entire nation will scrap these sets overnight to buy complete sound-television sets. Rather, the experimenter and builder will desire to retain his own, or the family's radio set; and he will then wish to build his own television set and, incidentally, get the experience in the new art that he could not get otherwise.

Television is here, and it is here to stay. Let no one think today that television is a dream and impracticable. The next two years will prove the writer's contention.

TELEVISION STATIONS IN THE UNITED STATES

Power Watts	103.5 meters—2900 kilocycles
500	W2XR—Radio Pictures, Inc., Long Island City (New York) N. Y.
500	W3XAD—R.C.A. Victor Co., Camden, N. J.
5,000	W3XK—Jenkins Laboratories, Wheaton, Md. (Washington).
5,000	W9XR—Great Lakes Broadcasting Co., Downers Grove (Chicago), Ill. (WENR).
107.2 meters—2800 kilocycles.	
250	W2XAP—Jenkins Television Corp. (portable).
500	W2XBA—WAAM, Inc., Newark, N. J.
500	W2XBO—United Research Corp., Long Island City (New York), N. Y.
5,000	W2XCR—Jenkins Television Corp., Jersey City, N. J.
20,000	W8XAV—Westinghouse Electric & Mfg. Co., East Pittsburgh, Pa. (KDKA).
1,000	W9XAP—Chicago Daily News, Chicago, Ill. (WMAQ).
139.5 meters—2150 kilocycles.	
500	W1XAV—Shortwave & Television Lab., Inc., Boston, Mass.
20,000	W2XBS—National Broadcasting Co., New York, N. Y. (WEAF, WJZ).
500	W2XR—Radio Pictures, Inc., Long Island City, N. Y.
20,000	W2XCW—General Electric Co., South Schenectady, N. Y. (WGY).
5,000	W3XAK—National Broadcasting Co., Bound Brook, N. J. (WJZ).
20,000	W8XAV—Westinghouse Electric & Mfg. Co., East Pittsburgh, Pa. (KDKA).
146.4 meters—2050 kilocycles.	
20,000	W1XAE—Westinghouse Elec. & Mfg. Co., Springfield, Mass., (WBZ).
250	W1XY—Pilot Radio & Tube Corp., Lawrence, Mass.
500	W2XBO—United Research Corp., Long Island City, N. Y.
100	W2XBU—Harold E. Smith, North Beacon, New York.
5,000	W2XCD—De Forest Radio Co., Passaic, New Jersey.
5,000	W3XK—Jenkins Laboratories, Wheaton, Md.
20,000	W8XAV—Westinghouse Elec. & Mfg. Co., East Pittsburgh, Pa. (KDKA).
1,000	W9XAA—Chicago Federation of Labor, Chicago, Ill. (WCFL).
500	W9XAO—Western Television Corp., Chicago, Ill.
1,500	W9XG—Purdue University, West Lafayette, Indiana, (WBAA).
10	W10XU—Jenkins Laboratories, (airplane).

Service Men's Department

This department is about the Service Man, for the Service Man, and largely by the Service Man. Its contributors are practical men, and we invite every Service Man in the country to tell about his own experiences of all kinds.

Edited by JOHN F. RIDER

UNCONVENTIONAL VOLTAGE DISTRIBUTION

By John F. Rider

SOME time ago we gave the advice: "Take Nothing For Granted." The need for continually bearing that rule in mind is shown by an examination of the "B" eliminator voltage-distribution systems in use in many modern receivers. Not until the development of some defect in the eliminator proper, does one realize how different modern systems are from those used years ago. Not that all modern receivers differ from the older type in this respect, because quite a few receivers being made today employ simple voltage dividers; but rather that many receivers employ somewhat complex arrangements, differing at least enough to cause much grief and aggravation until discovered.

A voltage drop is a voltage drop, no matter where it is obtained. If the polarity is correct, the application and utility are limited solely by the existing requirements. For instance, in several modern receivers, the speaker's field coil is connected in the negative lead, and the total current through the winding produces a drop. Now this drop can be used as the grid bias; but, to complicate matters, a separate divider is shunted across the field winding to provide a bias equal to a fraction of the total drop across the choke. Hence one must remember that such arrangements are possible, and learn to recognize the system when it is in use.

Another peculiarity noted in certain installations is the use of a voltage-reducing resistance right in the midst of the filter. Such is the case with the output tube's voltage-supply lead; but we refer to voltage-output leads which are associated, not with the output tube, but with the detector tube instead. When seeking this lead one would naturally search for some tap upon the divider. Such is its location in the majority of installations; but do not overlook the fact that the voltage may be secured from any part of the filter, if the correct voltage-reducing resistance is available. Not only is this resistance located external to the regular voltage divider and connected at the normal position of the output tube's plate voltage (at the mid-point connection between the two filter chokes) but a separate choke-and-condenser filter section is also an adjunct of the plate-voltage lead. Thus we have three filter sections, only two of which are in line; while the third is a separate circuit carrying only the detector plate current.

If you believe that the conventional design of a voltage divider is universal these



MR. JOHN F. RIDER, who passes upon all the material submitted for publication here, in the Service Men's Department, is a radio engineer of the first rank who has devoted much energy to the popularization of technical knowledge. None excel him in the art of making difficulties clear; he is a practical instructor, and the author of books known by all Service Men as useful guides. Letters, stories, requests and suggestions for this department may be addressed to him in care of RADIO-CRAFT.

days, you are wrong. A resistor may be connected across the output of the eliminator filter system, but it need not necessarily be the voltage divider. Separate resistors, joining at the maximum positive lead, reduce the voltages for the respective plate circuits; and, when they are operated in conjunction with separate by-pass condensers, they constitute individual resistance-capacity filters in each plate system.

We are accustomed, when visualizing an A.C. power pack, to imagine just one resistor connected across the maximum plus and maximum minus leads, and functioning as the combination voltage divider and bleeder resistance. Such systems still exist, but other systems cause the confusion. It is not a rare occurrence these days to analyze a receiver and discover, when the circuit is traced upon paper, that the voltage-dividing resistance comprises two or more separate systems connected across the eliminator output and, in addition, a third divider of the potentiometer type connected across a portion of one of the two dividers. Such a system may be explained as a single resistance used as a bleeder across the eliminator, with a divider connected across one portion of this resistance and serving to supply a variable screen-grid bias. The second divider across the eliminator is a

combination of voltage-reducing and bleeder resistances, connected to the grid-bias resistors for some of the tubes; so that the actual bias is due, not solely to the tube's plate current, but also to supplementary current furnished by or through the additional bleeder resistance.

It is not surprising, these days, to check a receiver and find three or four bleeder resistances in the voltage-distributing system.

The grid-bias resistance, employed to furnish the bias in either a cathode or a filament type of A.C. tube, need not be a separate resistor located in the cathode circuit or in the filament center-tap and "B—" circuit. It can be a part of the bleeder resistance; as in the days of old when eliminators were in use, but A.C. tubes were just coming. The fact that the junction of the bleeder resistance (part of the voltage divider) and the filament center-tap or the tube's cathode appears to be at some positive potential does not mean that a positive bias is being applied to the tube. Such has been the impression of many Service Men who have examined such circuits. If you check the system you will find that the most negative part of the "B" supply is grounded; while the junction between the voltage divider or bleeder resistor and the filament center-tap or cathode (generally classed as being some value of "B+") is actually "C+" and, according to old forms of layout, would be also "B—." The confusion arises because the voltage observations upon the receiver check normal, yet the schematic diagram appears erroneous.

As a point of information, we listened in upon a conversation relative to a supposed error upon a schematic diagram. While it is true that no one is infallible, do not come to a hasty conclusion that the drawing is wrong, simply because the circuit arrangement does not correspond with your ideas. Perhaps you are right; but check it once again and be certain.

Every effort is being made these days to isolate plate circuits. This means that plate voltages are controlled by individual voltage-reducing resistors, and failure of one resistor does not necessarily interrupt other plate circuits. Do not for one moment take for granted that lack of plate voltage upon one tube means a similar condition in all of the other associated stages. If you do, you are in for a sad disappointment.

The fact that a single cathode resistor is used to furnish the grid bias for more than one stage in a system does not necessarily mean that the voltage drop is due solely to the combined current of those three tubes. If the resistance is checked and the drop

(Continued on page 295)

Leaves from Service Men's Note Books

The "Meat" of what our professionals have learned by their own practical experiences of many years

By RADIO-CRAFT READERS

A REMOVABLE ADAPTER PLUG

By Edwin T. Phillips

MY four-prong adapter would stick in a UX socket whenever I was trying to remove it after testing a '26, '71A or kindred tube; and my hand would come away with only the five-prong test plug, leaving me the job of extracting the adapter—and how it would stick!

I finally devised the simple method of curing this trouble shown in Fig. 1, which represents the gadget I devised for my Sterling "R522" tester. The little clip (B) was made from a "Model A" Ford spark plug lug, and fixed to the back (opposite the bayonet pin) of the 5-prong test plug (A) by an 1/8-inch screw (at C). It carries an 1/8-inch pin (D) which normally is swung up out of the way; but when the 4-prong adapter is used, it is swung around and engages the hole bored into the adapter (at E). When the plug comes up, the adapter does too.

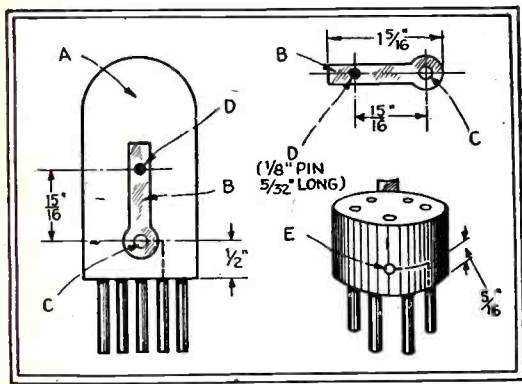

Fig. 1

Mr. Phillips puts a little catch on the 5-prong plug of his tester, which insures the extraction of the UX adapter from the socket.

A GLOW-LAMP TESTER FOR CONDENSERS

By J. B. Calpark

THE most efficient trouble lamp I have ever used is a type 874 voltage regulator, used as shown in Fig. 3, with a 10,000-ohm variable resistor in the other leads from the house lines. It is especially useful for testing fixed condensers, since very little current is needed to produce a purplish glow. If the slightest amount of glow appears in a tube when a condenser is under test, the condenser is leaky or due for a "blow." (A large condenser will give an instantaneous glow while it is charging, although it may be in good condition.—Editor.) Some tubes have to be warmed up, by shorting the test leads, for about 30 seconds, before they will glow on a leaky condenser.

The adjustment of the resistor is not critical; vary it until the tube glows distinctly. If you are in doubt whether a condenser leaks, turn the variable resistor up to full; if the tube does not glow, the condenser is undoubtedly O. K. The tester may be used for any number of continuity

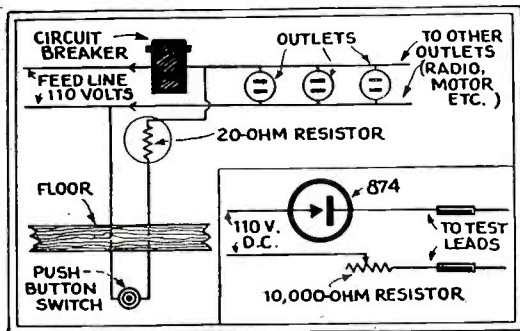

Fig. 2 Fig. 3

Left and above, a simple connection of a relay to shut off the radio and other appliances while telephoning. Right lower, another continuity tester, using a glow-lamp.

tests on circuits, etc.

I hope you will be able to use this idea; for I feel I should do something to repay you for the many helpful ideas I get from RADIO-CRAFT. Keep it up!

(The apparatus shown may be used with A.C. lines for continuity tests; but it must be remembered that a condenser in good condition passes alternating current.)

A REMOTE CONTROL

By John J. Nothelfer

IT is a great annoyance and trouble when downstairs to run up and shut off radio, motor or whatever is causing noises when the telephone rings.

A circuit-breaker installed in the line leading to my laboratory gave the idea of stopping any noises, such as radio, motor, etc.

The circuit breaker is wired up as in the usual manner and a double-wire cord was led from one of the A.C. outlets downstairs to a push button (see Fig. 2). When the button is pressed, it forms a contact and causes the circuit breaker to break the flow of current. A 20-ohm resistor is wired in series with the push button, to prevent undue arcing when the breaker opens. The circuit breaker is a home-made affair, but this idea may be used on any factory-built breaker.

At the left, a photograph showing the operation of Mr. Nothelfer's relay which insures electrical quiet while telephoning. So long as the button is pressed, the radio and other appliances are shut off. (The idea of connecting a cut-off switch directly to the telephone receiver has recently been patented.)

At the right, the house wiring is shown on a wall panel; the circuit breaker is indicated by the arrow. It is connected to the push button upstairs as diagrammed in Fig. 2.

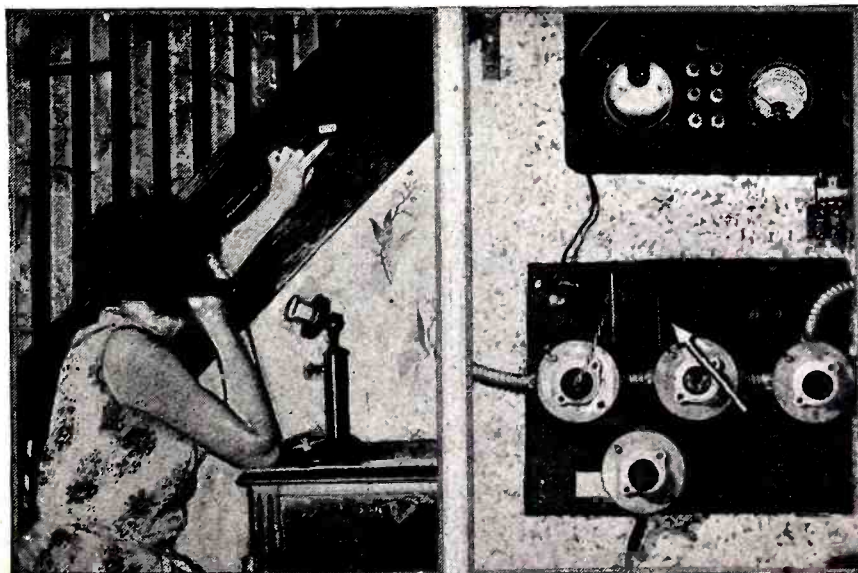

REWIRING A.C. SETS

By Wayne A. Lindsey

WHEN rewiring A.C. sets for heater-type tubes, it is sometimes possible, by using a series or a series-parallel filament connection, to make use of old transformers which were designed principally for the direct-heated type of tubes. The schematic circuit of Fig. 4 shows how a set was rewired to use eight heater-type tubes, by lighting six of them from the rectifier tube winding and the rectifier tube filament from the old power-tube winding; this winding was rated at one ampere but provided sufficient current to operate the rectifier satisfactorily without undue heating of the transformer. All other windings are operated within their power ratings.

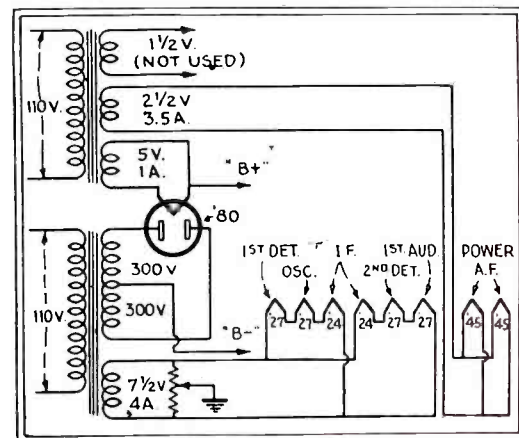

Fig. 4

Mr. Lindsey suggests the following method of rewiring early models of A.C. sets to use '27s and '45s instead of '26s and '10s.

SPEAKERS AND TERMINALS

By Edwin T. Phillips

WHEN you are dealing with a limp, soft, paper cone, a coating of paste (common starch will do) on the inner side will often work wonders, leave about an inch around the edge unpasted; as this will

allow the cone to move in a flexible manner and avoid rattle.

On cheap speakers, pay especial attention to the cord tips when testing continuity. Many speaker cords have only a cheap, soft rubber covering which will run badly when the tips are being soldered on. Result, a tip full of gummy rubber with a single wire, perhaps, making contact.

Since many sets have no terminal indicators, I make a point of printing in ink, on a card about 1x2 inches, the colors and their respective connections. This I fasten with two thumb tacks to the inside of the cabinet.

I twist no wires around binding posts, either; terminals are soldered on and insulating bushings pushed over the terminals. Result, a good-looking job; and the customer thinks you are the whole works when you turn over to him a job done in the manner described. He tells the other fellow about it; I have learned that, even if I am fresh in the game.

The pinch-bar mechanic is being eliminated, and the fellow who means to "get there" must keep on his toes. I think it is well to take Mr. Rider's advice (in the June issue) and "Study!"

HOW TO FILE SERVICE DATA

By Albert Corideo

MY scrap book, a page of which I reproduce for you, will give an idea how I systematize the clippings which I get out of RADIO-CRAFT. In the first place, I always purchase two copies of RADIO-CRAFT; one I keep intact in my file, the other I cut up for my scrap book. All service notes, diagrams, etc., are cut out and pasted on the proper pages.

For instance, when I cut out a service note on a Victor set, I place this under the Victor heading; I have allowed five pages to each heading. If there is something of interest on the under side of a clipping, instead of cutting up another book, I just make a note of the facts for reference on the proper page. I have tried other methods, and found this the quickest and best.

The Radio Service Data Sheets I file in a binder; and on the front cover I list the names of the receivers, in the order that

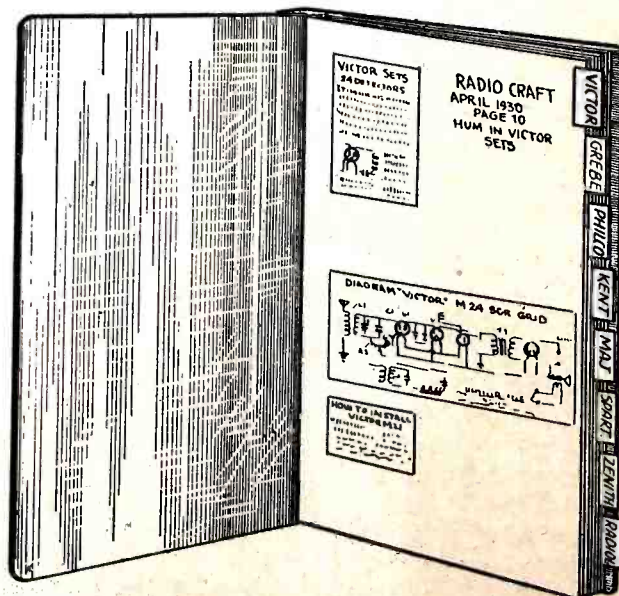
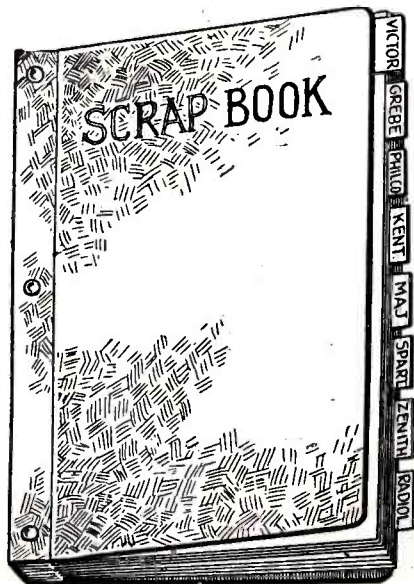
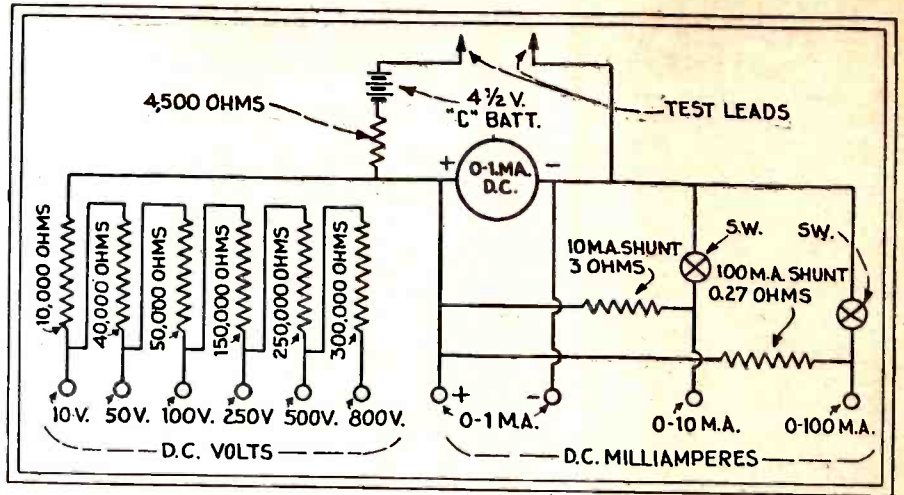

Fig. 5

Mr. Corideo's system of filing places, not merely data sheets, diagrams, tables, etc., but even casual notes about radio sets at his disposal when he wants them. Every Service Man should have an up-to-date scrap book at hand.

Fig. 6
Mr. Demma's layout for his meters is simpler and cheaper to build than the push-button and rotary-switch type. The scales are selected through tip jacks. Resistors of reasonable accuracy may now be purchased at comparatively low rates. For the Service Man who cannot afford a finished "portable laboratory," this outfit will be very useful.



they are to be found inside. I hope that this hint will be useful to brother Service Men.

I have been in this business eight years; and am a graduate member of four associations, including the R.S.M.A. I have bought all kinds of radio magazines, but have yet to find the one that will beat RADIO-CRAFT.

(This method of filing supplemental notes, other than the diagrams of complete sets, on servicing methods for specific receiver models, may be applied to special advantage by owners of the OFFICIAL RADIO SERVICE MANUAL; the loose-leaf construction of which makes it easy to insert notes of this kind.—Editor.)

AN ECONOMICAL LAYOUT

By J. Demma

BEING one of the many Service Men whose financial standing does not allow me to invest a great deal of money in the purchase of an assortment of high-class meters, I hit upon a little scheme of employing one millimeter to do the work of several. It serves me as a multi-range high-resistance voltmeter, a three-range millimeter, an ohmmeter, and a continuity tester. The simplicity of the arrangement, shown in Fig. 6, speaks for itself.

The meter used was a Weston "Model 301," 0-1-ma. scale; this has a resistance of 27 ohms. The resistor connections shown are tip-jacks. The 4 1/2-volt "C" battery

needed for resistance measurements is also contained in the same case, with tip-jacks leading through the panel. The 4,500-ohm resistor, leading to the positive side of the meter, is used in series with the test points, for continuity and resistance tests; giving full-scale reading, it will be seen, with an external short-circuit.

To make the 0.27-ohm resistor for the 100-ma. shunt, an 0.4-ohm resistor was taken and turns were shorted out until the right value was obtained. With a meter of any other type, the necessary shunts may be easily figured. Multiply the resistance of the meter by the current which it draws at full-scale reading; then divide this product by the total current, which it is desired to read at full scale, less the current now taken by the meter. The result is the value in ohms of the desired shunt. It makes no difference, in this calculation, whether the current is reduced from milliamperes to amperes or not.

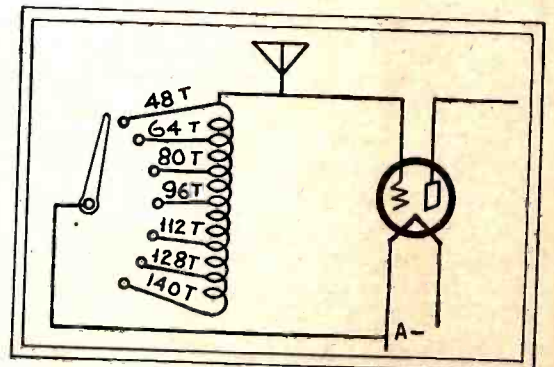

Fig. 7

The tapped inductor still has merits.

SEMI-TUNED INPUT

By E. E. Kanouse

IN some of the early T. R. F. models, the input of which is aperiodically coupled, and followed by only two tuned stages (the A.K. "Model 35" for instance), a pronounced improvement may be made in the following manner:

Remove the R.F. choke from the input, and substitute a variable inductor of 140 turns of No. 30 D. S. C. wire on a 2-inch tube, space-wound and tapped at the 48th, 64th, 80th, 96th, 112th and 128th turns.

A 7-point inductor switch is mounted on the control panel, and the coil leads are soldered to their respective taps, as indicated in the accompanying schematic diagram (Fig. 7). The resulting semi-tuned circuit will be much more responsive to distant reception; while no disturbing effect on the ganged tuning condensers will result.

Operating Notes for Service Men

As a rule a commercial set, however well built, must have some point weaker than the rest at which trouble may be first experienced. Here are a few suggestions on where to look for trouble in certain commercial models.

By BERTRAM M. FREED

IN previous articles, much has been said of the Colonial "32 A.C." model; but some additional comments may not be amiss. A short time ago one of these sets occasioned much annoyance to the writer until the trouble was discovered. The complaint was lack of both sensitivity and selectivity. The tubes were new, the antenna system good, and all circuits tested O. K. After a few hours, it was found that the screw holding the driving belt (Fig. 1) to one of the condenser drums had been broken; so that when the belt moved, it failed to turn the drum. The result, of course, was that one circuit was improperly tuned.

The high amplification of this model causes it to be extremely noisy in some locations, especially where trolley or elevated cars run nearby. However, in some cases interference, seemingly from an external source, has been traced to the dual volume control in the receiver. The two shells spread as the knob is manipulated; and undue wear on portions of the high-resistance coating results. The quickest remedy is replacement.

Another source of similar "interference" effects is found in the fuse clips, which are riveted to a bakelite strip under the set chassis. Vibration loosens the rivets and causes faulty contact, which produces arcs and considerable disturbance.

In the direct-current Colonial "32," quieter reception and an improvement in tone and volume have been obtained by changing the connection of the by-pass condenser which is wired between the screen-grid of the detector tube and ground, to directly between screen-grid and cathode. This has been successful in several cases in which it has been tried.

In a new Colonial "33 A.C.," which had been sent back to the shop for repairs, it was found that the complaint of "few stations and poor quality" was caused by an open circuit on one side of the 200,000-ohm center-tapped resistor which gives the first '24 tube its control-grid bias. In this model, also, care should be taken in the selection of a perfect '24 for the detector tube, which is most critical.

The "Kylelectron" Speaker

The Peerless "Courier," which utilizes the "Kylelectron" electrostatic reproducer, makes use of an additional rectifier, a UX-'99 tube, to supply the necessary potential (about 600 volts) to polarize this capacity. The reproducer is made up of six individual sections, wired in parallel. One side of each section is perforated sheet metal; the inside plate is ordinary tinfoil, to which connection is made by screws which are separated from the outer metal by insulating discs (see Fig. 3). If the reproducer or the cabinet is roughly handled, these

discs may shift and short the two plates; as the sections are in parallel, shorting one shorts all.

To find the shorted section, each of the six may be disconnected and tested singly with a continuity apparatus. Any section may be removed in order to substitute a new one, by taking out the screws holding it to the frame; some repairmen simply clip the defective section out of the circuit. One service organization, to the writer's knowledge, because of the difficulty of obtaining replacements, uses the good sections of a defective speaker to repair others which may come in. A section which is becoming defective will manifest itself by very noisy

plate lead at the same time, will take care of this last problem.

Miscellaneous Troubles

When noisy reception in a Majestic "92" showed itself above 470 meters, the first thought was trouble with the equalizer; and the second, of shorted condenser plates. The latter seemed unlikely in so sturdy a chassis; but a thorough test showed that it was the case. A thin metal lamination had peeled off from several of the stator plates and would short to the rotors, if the chassis was subjected to more than ordinary vibration. A small metal file (not unlike a nail file) soon rectified this trouble.

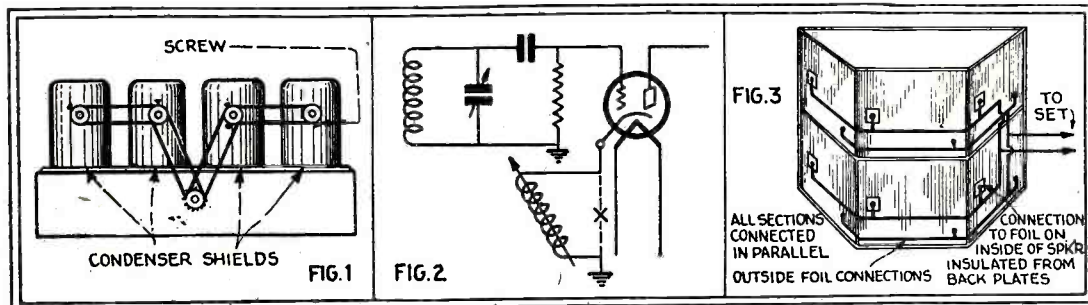

At the left, condenser-drive of the Colonial "32 AC"; center, the best way to introduce a phonograph pickup into a "Radiola 33," or similar detector circuit. The right shows the connections of the electrostatic speaker or "Kylelectron" in the Peerless "Courier" model.

reception and interruption of the signals, due to the temporary breakdown of the insulation and shorting of the two plates.

Another defect which may be experienced in the Peerless receiver is a broken connection in the coupling condenser of the resistance-coupled stage; that is located underneath the pack chassis. The symptoms are choppy or weak reception.

Adding Phonograph Pickup

Connecting a pickup to a Radiola "33 A.C." involves some difficulty, due to the effect of the added capacity of the leads. While the most stable circuit condition is that where the pickup is connected in the plate lead of the detector, the amplification of the two audio stages is not sufficient for good loud-speaker volume. Connection between grid and cathode will give the best results, provided a high-resistance pickup is used; but the length of the leads required by the "radio-phonograph" switch may introduce capacity enough to muffle reception and cause oscillation. Perhaps the best method is to open the cathode return of the detector and place the pickup in series between cathode and ground (Fig. 2); a shorting switch across the pickup will throw it into and out of circuit. A low-resistance pickup will operate best in this position. However, when it is connected this way, radio reception will come through with the recording, unless the volume control is turned all the way down. The use of a D.P., S.T. toggle switch, to open the R.F.

Excessive oscillation in the Atwater Kent "55 A.C." is usually remedied by realigning the tuning condensers; but sometimes this is not sufficient. Then severe cases may be corrected by placing the metal vibration damper, which is furnished with this set, over the detector '27 and connecting it to the stator plates of the detector tuning condenser by means of a jumper. Before trying these suggestions, it is well to apply the usual tests for open circuit to the R.F. by-pass condensers.

In the new Fada model (that using the "Flashograph"), do not mistake the screws of the small compensating condensers, atop each tuning condenser in the gang, for mere mounting screws.

THE FLYING SERVICE MAN

By R. Douglas Clerk

AS a Service Man of long standing, connected with radio and "wireless" since the days of *Modern Electrics*, I am endeavoring to stress the importance of "Visual Inspection" when called on to service a radio set, by describing one day's experience.

This typical day of the writer's work is absolutely authentic in its record; the date was February 4 of the present year. (I have had many bigger days, but I make it a point to stop work always at 7:00 p.m. A man cannot keep up this pace day and night; in fact, I have found in the past that,

(Continued on page 295)

RADIOLA-VICTOR R 80—WESTINGHOUSE WR5—GRAYBAR 700—
GENERAL ELECTRIC H-31

In the diagram is shown what might be termed the "foundation chassis" of a number of superheterodyne receivers of different trade names and external designs. This is the fundamental circuit plan recently released to all the Radiola-Victor licensees.

To the experienced Service Man it will be evident that extreme care must be taken in servicing these receivers, in order to maintain perfect circuit balance.

The figures in parentheses represent the resistance of each element of the circuit. The capacity values are as follows: C1, C2, C3, C4, 18 to 330 mmf.; C5, C6, C7, C8, C9, C10, 120 to 220 mmf.; C11, 745 mmf.; C12, 4.5 mmf.; C13, C15, C16, C19, 0.1-mf.; C14, 0.5-mf.; C17, 1.0 mf.; C18, .0024-mf.; C20, C21, 3 mf.; C22, 2 mf.; C23, .05-mf.; C24, 3 mf. (for 25 cycles only); C, 745-mmf.

Normal operating readings with volume control R2 at maximum and local-distant switch at "distant," are as follows:

Plate voltages, V1, V4, V5, 240; V2, 70; V3, 235; V6, 210; V7, V8, 200. Plate currents; V1, 4 ma.; V2, 6 ma.; V3, 0.25-ma.; V4, 5.5 ma.; V5, 2 ma.; V6, 0.5-ma.; V7, V8, 30 ma. Control-grid voltages; V1, V4, 2.2; V3, 8; V5, 5; V6, 23; V7, V8, 20. Screen-grid voltages; V1, 90; V3, 80; V4, V5, 85; Filament voltage (between 2 and 3 on the terminal strip), 2.5. Power-pack output voltage (between 4 and 5 on the strip), 250.

The antenna coupler L1 has a high-inductance primary coupled to the first of two tuned coils in slight inductive relation, thus forming a highly-selective link circuit preceding a stage of signal-frequency amplification, V1. The R.F. choke Ch1 in the plate circuit of the latter has a high inductance.

The color code for the main cable is: 1, red with yellow tracer; 2 and 3, brown; 4, yellow; 5, red.

By using the principle of the auto-transformer in the design of filter choke Ch3, a voltage 180 degrees out of phase with the ripple voltage is caused to cancel the latter; the field coil of the dynamic reproducer completes the filtering job (the current through this coil is 85 milliamperes and the drop across it is 110 volts).

Compensation for line voltage is obtained by changing the position of the fuse, which is of 5-amp. rating. A blown fuse may be due to a short in a pack condenser, the rectifier V9, the filament leads, or in the pilot-light socket.

Jerky action of the station selector may be corrected by adjustment of the condenser-drive cable spring or by placing a few drops of oil on the condenser bearing.

Remember that when this set is located close to a powerful station, better volume control may be obtained by removing R3.

Should a noisy volume control fail to respond to treatment with a pipe cleaner and cigarette-

lighter fluid, it will probably be necessary to change the control.

Acoustic howl may be due to defective rubber cushions, wood shipping blocks not being removed, microphonic tube, or chassis not swinging freely in the rubber cushions.

Low volume may be caused by defective tubes, poor antenna system, or condensers out of balance (in either R.F., oscillator, or I.F. circuits), defective A.F.T.'s., shorted field coil (check current through coil), or opens, shorts or grounds in set or pack chasses.

This chassis is practically humless. Excessive hum, however, may be due to these defects: poor '80, open or shorted Ch3, defective condensers, shorted or open resistors.

Distorted reproduction not traceable to reproducer may be due to one of the following conditions: defective tubes, circuit oscillation (resulting in whistle on stations, where the whistle is not due to the heterodyne of two stations), defective A.F.T.'s., faulty alignment of tuned circuits, tuning slightly off the correct tuning point, strong local station, open or shorted condensers or resistors.

Audio howl often may be traced to defective tubes (particularly V6, V7, V8), open condensers, or circuit oscillation at R.F. causing heterodyne with station carrier.

Circuit oscillation and misalignment of the tuned circuits are probably the two foremost troublesome factors in this receiver. The former is fairly easy to locate and remedy by ordinary service procedure; the latter should not be attempted by anyone not experienced in superheterodyne repair, or anyone who has not made a careful and thorough study of the method of balancing the several circuits.

Circuit oscillation when localized will probably prove to be due to shielding not making proper contact, control-grid leads out of position or not making good contact, open by-pass condensers, defective screen-grid tubes, or separate grounding lead from by-pass condenser case not connected.

In addition to the five circuit-balancing condensers in shunt with the four tuning condensers and the fixed condenser C, there are five adjustable sectors on each of the four tuning condensers. These are adjusted by studs; as they were balanced carefully at the factory it is not likely that it will be necessary to touch them.

However, it may be noted that these sectors are adjusted for five positions of the test oscillator: 1120 kc., 840 kc., 700 kc., 600 kc., and 550 kc. (with the condenser so meshed that the slot of the sector under adjustment, and the next highest capacity, are level with the edge of the stator plate.)

For this adjustment, there will be required a socket wrench, an audio modulated oscillator, and a 0-2-scale milliammeter connected in the plate circuit of the detector. (This connection

may be obtained through an adapter that breaks the plate circuit, or by unsoldering the wire that is connected to the plate socket-contact and connecting the meter to this lead and the socket contact.) Then, remove the oscillator tube and connect a 20,000-ohm resistor from the socket plate connection of V2 to its cathode. These connections are to be made with the receiver out of the cabinet and a ground connected to the set.

This is a sketchy outline of the procedure (seldom necessary) in lining up the gang condenser; but to do this work correctly involves considerably more detail data than this space permits. Hence, these adjusting studs should not be touched until the complete service data is available; as it is necessary after this adjustment to check over the I.F. condensers, and the scale and oscillator readings.

A modulated oscillator is required adjustable to exactly 600 kc. and to 1400 kc. for balancing the R.F. circuits. A suitable indicating device is a 0-5-scale milliammeter connected in the plate circuit of V6. Set the local-distant switch on "distant" and adjust the 600-kc. oscillator trimming condenser on the chassis, (between the second and third variable condensers), about three quarters of the way in. Now, set the oscillator in operation at exactly 1400 kc., turn the selector knob until the scale reads 1400 kc.; and adjust oscillator, first detector, R.F., and link-circuit trimming condensers, in the order given, for maximum output. Then, with the oscillator readjusted to 600 kc., adjust the 600 kc. trimming condenser while rocking the gang condenser back and forth. (The dial scale should now read 600 kc.) Readjust oscillator to 1400 kc. and set the selector scale at exactly 1400 kc.; then adjust the four trimming condensers, in the order C3, C4, C2 and C1, for maximum meter indication. Place the oscillator again in operation at 600 kc., tune in the signal, and the scale at maximum meter deflection should indicate 600 kc. Otherwise, repeat the former operations.

The I.F. transformers peak at 175 kc. and are so designed as to require a test oscillator variable from 171 kc. to 179 kc., for aligning them.

Making sure that there is a good ground connection, put the set in normal operation, place volume control at minimum, and remove V2. Connect a meter in the output circuit of set and connect the coupling lead of the oscillator to the control grid of V5 (oscillator set for 175 kc.). Adjust C7 and then C10 so that there is no appreciable drop in the meter reading between 172.5 and 177.5 kc., and an equal drop at 171 and 179 kc. After adjusting the tuning of L7, repeat the operation for L6, putting the test oscillator output lead on the control-grid connection of V4. Finally, shift the oscillator lead to the control-grid of V3 and balance the circuits of L5 (which will tune very sharply).

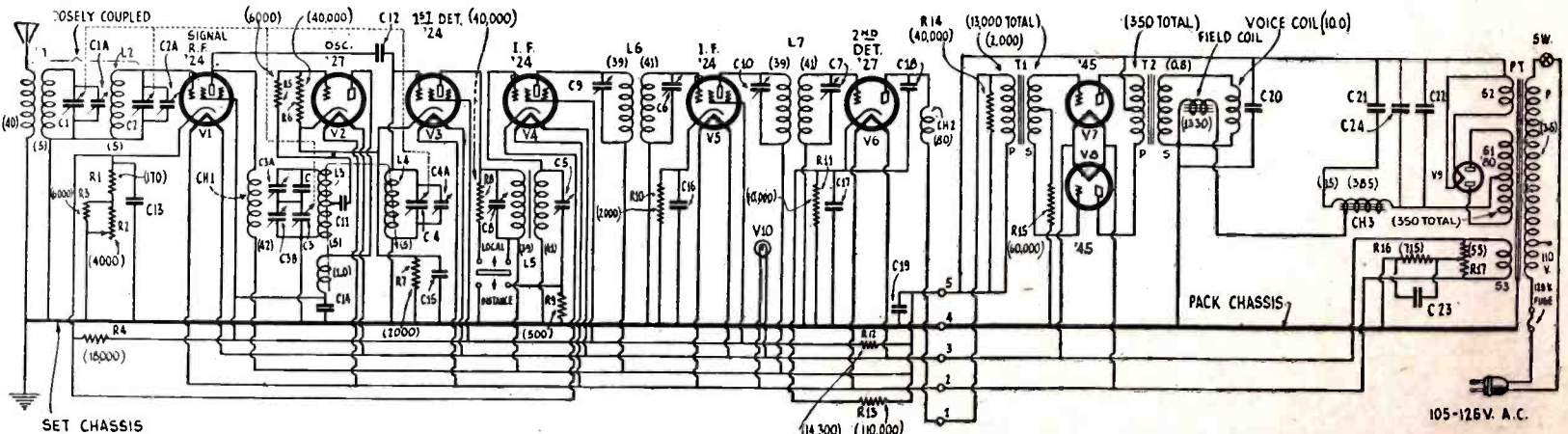

GREBE SUPER-SYNCHROPHASE A.C. RECEIVER MODEL SK-4

This A.C. screen-grid receiver, a product of A. H. Grebe and Co., Richmond Hill, N. Y., incorporates a band-selector input to the first R.F.; the resistor bypass-condenser type of filter in control-grid, screen-grid and plate leads; a power detector; push-pull '45's; and an auto-transformer (Phono. T., in the diagram, with common tap C, low-impedance pickup tap L, and high-impedance pickup tap H) for phonograph pickup connection.

It is important that the correct line ballast be used at R21, in accordance with the following line-voltage ranges and ballast model numbers: 95-110 V., No. 6310; 105-125 V., No. 6412; 115-138 V., No. 6420; 213-252 V., No. 5932 (used in special 230-volt, 60-cycle sets); 107-129 V., No. 2404 (in 25-cycle sets.)

To remove chassis: Take off the knobs of the volume control R13 and local-distance switch SW1; remove the five screws holding the panel escutcheon; loosen lock-nut holding SW3 to escutcheon, and then remove knurled ring on front of this plate; loosen hook-bolts holding R.F. chassis to console; disconnect cable at terminal plate, and lift out chassis.

Following are the constants of the units comprising this set: R1, R2, R6, R8, R10, 20,000 ohms; R3, R7, R11, 1,000 ohms; R4, R14, 7 ohms; R5, 152 ohms; R9, R22, 1/4-meg.; R12, 1/10-meg.; R13, 2,800 ohms; R15, 677 ohms; R16, 2,200 ohms; R17, 62 ohms; R18, 7,000 ohms; R19, 10,000 ohms; R20, 1,500 ohms; dynamic reproducer field coil, 650 ohms.

The condensers in this receiver have the following capacities: C1, C2, C3, C4, C5, C7, 350 mmf.; C6, C11, C12, C13, C14, C15, C16, C17, C18, C19, C25, 0.1-mf.; C8, C9, C10, 7 mmf.; C20, .002-mf.; C21, 1.0 mf.; C22, 1.5 mf.; C23, 1.5 mf., C24, 2 mf.

Coupling coil L6 has 6 turns of bare No. 26 wire wound on a tube about 1 1/8 in. in diameter, the turns being spaced about 1/8-in.

Hum is occasionally traced to reversed field coil connections to the reproducer. Other sources of audio distortion are included in this listing: loose fiber wedges between the transformer windings and core; power transformer cover not tight; tube shields loose; loose chassis hooks or bolts; console doors not fitting well; poor contact at caps of control-grids; defective cone paper.

Circuit oscillation may be a matter of tubes. Then again, the ground may not be sufficiently good; or even an accumulation of dirt under the contact brakes on the condenser rotor shaft may cause circuit oscillation (usually between

550 and 700 kc.). Merely clean the contact surfaces—do not use oil.

Compensating condensers of about 30 mmf. capacity shunt each of the tuning condensers, although they are not shown in the diagram. The leads from these units to the coils must be correctly placed with regard to the chassis and each other, in order to prevent circuit oscillation.

Circuit oscillation not remedied by any of these corrective measures may respond to adjustment of the three adjustable "gain screws" protruding through the base of the R.F. chassis; these screws control C8, C9 and C10. This adjustment will not be necessary except in rare instances. At the factory the correct setting is obtained by turning down the screws tightly and then backing them all out, 3/4-turn each. If this position does not stop oscillation, the screws may be turned out an additional 1/16 or 1/8 of a turn. (More than 1/8-turn will change the resonance of the tuned circuits and necessitate re-calibration of the kilocycle scale. The over-all sensitivity of the receiver is also reduced by turning out the gain screws—which are most effective for correcting circuit oscillation in the frequency range from 1200 to 1500 kc.)

Checking the alignment of the gang condenser is accomplished by watching for maximum reading on an 0-5 or 0-10 ma. milliammeter (or, an 0-15, or less, voltmeter connected as a milliammeter) in the plate circuit of detector V4, when an audio-modulated R.F. oscillator calibrated at 1400, 800, and 550 kc. (used in this order) is the circuit driver. The circuits of L1, L2, L3, L4, may be checked by inserting a small shorted coil (on the end of an insulating bar) into these inductances; correct adjustment being shown by a reduced reading on milliammeter (increased reading denotes circuit out of resonance; and reducing the inductance of the coil, through use of the shorted ring, has brought the circuit into resonance with the oscillator). Since L5 is covered by a shield can, which, if removed, would throw the circuit out of balance the shorted-coil test cannot be applied here; hence it is necessary to use the equivalent plan of carefully bending outward, slightly, the end plate of condenser C5, and noting the meter reading (which should remain fixed or decrease).

This procedure completes the check on the high-frequency side of resonance; now we will check the low side. Using an insulated rod, gently press inward the end plates of C1, C2,

C3, C4, and C5. This increase of capacity should result in the meter's indicating no change, or else a little reduction in the scale reading; an increase indicates lack of resonance on the low side of the oscillator frequency. The antenna condenser C7, is not in a sharp-tuning circuit and will not require balancing; incidentally, this condenser, mounted on the extreme right of the condenser gang, is insulated from the remaining condensers.

Before correcting an off-resonance condition, make sure that the three "gain" control studs are set as previously mentioned; then, if necessary, adjust (at 1400 kc. only) the aligning condensers on the rear of the gang-condenser frame in this order: C1, C2, C3, C4, C5.

If an alignment test at 800 kc. indicates the necessity for aligning one or more of the circuits, this may be done by carefully bending the rotor end plate at the point where it meshes with the stator, (the aligning condensers being used only at 1400 kc.). Repeat this cycle of operations at 550 kc.

Modulation hum in earlier sets (a strong 60- or 120-cycle hum heard only when set is tuned to one of several local, powerful stations) may be corrected by inserting a 1/4-meg. resistor in the lead to the arm of the volume control, and shorting the control-grid filter resistor of V2. As this change has been made in later production of the Super-Synchrophase, the circuit shown below incorporates these modifications; R9 is the 1/4-meg. resistor, and X1 denotes the former position of the filter resistor.

If strong local stations which are separated 30 kc. interfere with each other, the trouble is probably due to pickup via the light lines.

Weak signal, or no signal, may be due to the screen-grid tubes; and it may be handy for the Service Man to know that a convenient test may be applied. The screen-grid caps are removed and the control-grid is touched with a moistened finger; when a hum will result if the tube is good.

Fading and intermittent reception may be due to defective tubes, grid-to-cathode leakage, or intermittent grounds inside bypass or filter condensers. In the second instance, the fault will not develop until the tubes have been heated for some time; advancing the volume control then brings the signal back, but it fades again. The remedy is to replace R12, if it has a value of 3 megs. (silver ends), with a resistor of the type used in late sets. This is 1/2- to 1 meg., with brown ends.

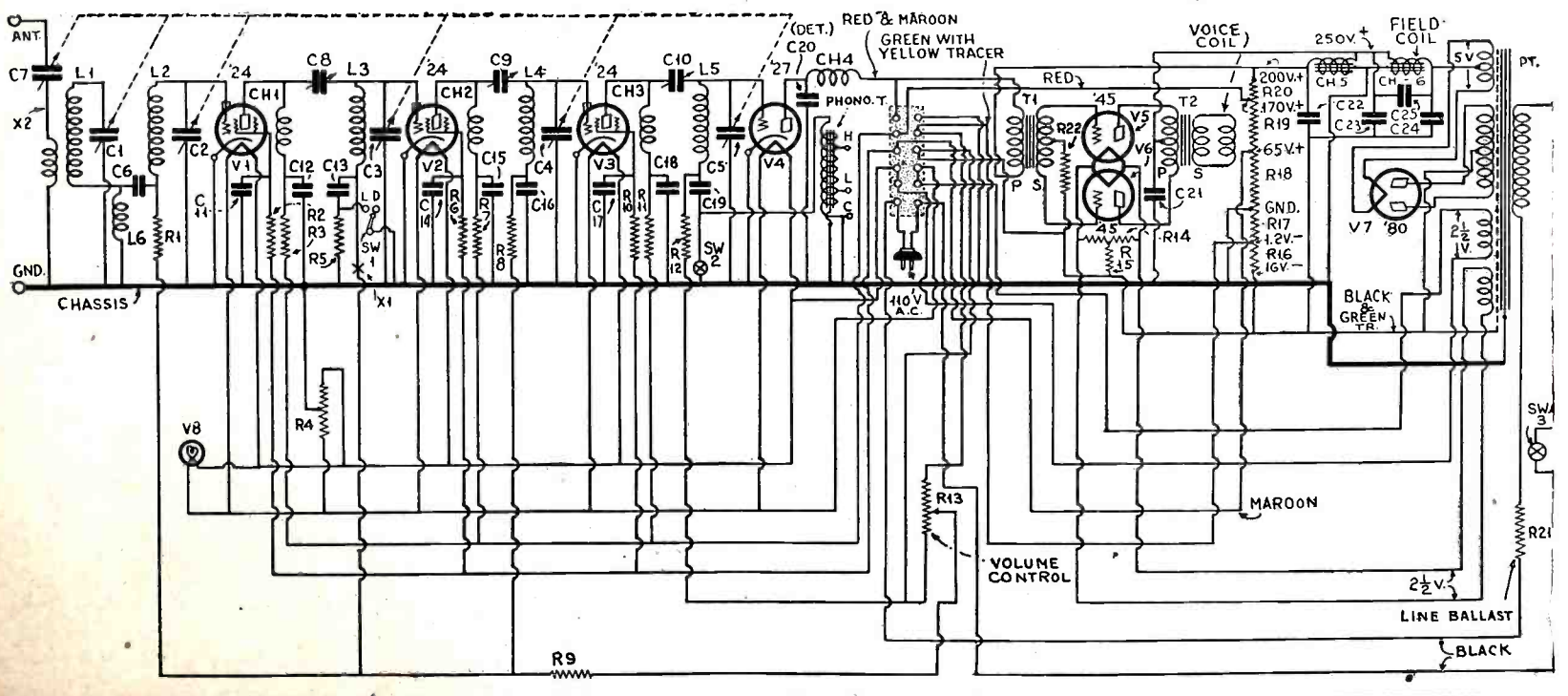

The Business End of Radio Servicing

A Service Man who has gone into business for himself tells how he gets business, handles it, and—note this—collects for it

By GEORGE K. GRAHAM

THE purpose of this article is not to tell how to fix radio sets, but to discuss the Service Man's relations to his customers, and how he can make the most of them. Experience has shown that service work is ten per cent. technical radio and ninety per cent. salesmanship.

The writer has met Service Men of all kinds and types; some are successful, some are not. A peculiarity he has noted is that the successful ones usually know the least about technical radio; while those who are more technically inclined do not seem to get fair prices for their work. The reason may be that the over-technical radio man is so engrossed with radio itself that he forgets he is in the servicing business primarily to make money.

Consider Your Investment

In passing, attention may be called to the fact that radio is a costly profession to learn. Perhaps it has not involved any actual expenditure for tuition itself; but remember that, as a business man, you should reckon in your investment, not only such items as textbooks, radio magazines and testing equipment which you have purchased, but the hours of time you have spent experimenting and finding out at your own expense the fundamental laws of electricity and radio itself. Remember too, the number of sets you have built at your own expense and torn apart and rebuilt countless times.

The story is the same, no matter what radio Service Man you ask; all seem to have learned the business in the same way. Take the number of hours you have spent in experimenting and multiply it by the average pay-rate of any so-called job. You will be amazed to find out just how much it did cost you to learn the radio business. Remember, too, that your days of experimenting

are not through; you can never stop, if you wish to keep up with this rapidly-changing industry.

If you had invested several thousand dollars in any other business, you would be perfectly justified in expecting a reasonable

THE Service Man is, like other laborers, proverbially worthy of his hire. While other Service Men have been telling us of the electrical and mechanical difficulties they have overcome, Mr. Graham recalls to our attention that the Service Man must not forget his own financial interests in his technical enthusiasm for solving problems. Whether the most successful Service Man is the one who knows the least about radio is an assertion open to some argument; the writer of this article is surely a capable Service Man as well as a business man.

But the sales methods described and illustrated here are worthy of consideration and, taking his own local conditions into consideration, many a Service Man can profit by the suggestions made here. We are always glad to hear from radio men about sales and promotion methods which they have found of cash value.

return on your investment; so with radio. Make it give you a reasonable return for the time and money spent in learning the business.

Many radio men, engaged in private service work, either for themselves or for dealers on a contract basis, take their business too lightly; they seem to look upon it as "just

a job." It is more than that; it is a profession, and can be made to pay professional compensation. Aside from the obvious need of being constantly posted as to new developments in the radio industry, and keeping up with the newer type of commercial radio receivers, the radio Service Man must follow the plans being used by sales organizations.

Go After Business

Promotion work can be successfully applied to radio service work and will give handsome returns. Your prospects are the people who bought battery sets years ago, and who are constantly patching them up to keep them going, those who bought the earlier electric sets, and those who have had their newer machines long enough to have passed the guarantee period. A large percentage of set owners have purchased their radio receivers from a dealer but will, through some misunderstanding (usually over credits, etc.), make a practice of having them repaired by some outside man. You may as well be the man to do this work for them.

Right now, in your own town, some one is wondering whom to call for radio service. Make it your business to reach these people. True, not every one you come in contact with needs service right now; but you know that tubes, condensers, resistors and transformers, etc., have a definite life. Set owners will need service sometime. Make them acquainted with your business; not after they have had service done elsewhere, but before, in time for you to get the job. Get to these people first, tell them your story, leave your name with them—then when they do need service they will think of you. Your business will be in direct proportion to the number of contacts you have previously made.

A good plan to follow is a combination of telephone canvassing and direct-mail advertising. You can call at least twenty-five people a day and offer them a free radio inspection. Your method of approach may be somewhat like this:

"Hello, Mr. Brown, this is Mr. Jones, the radio man. I have just started in the radio service business and, in order to become acquainted with the people in town I am offering a free radio inspection. I will be glad to come to your home and inspect your radio, test the tubes, and check the antenna and ground installation. How long have you had your radio, Mr. Brown?"

"You say your machine is a year and a half old? By the way, Mr. Brown, have you had the tubes tested lately? You know that sometimes you can get better reception if you rearrange the tubes in your set. I will be glad to stop up and test the tubes for you and try to get you the best reception possible. I am doing this just as a sample of my work; so that when you do need service you will know where to call."

EMERY HOME APPLIANCE, INC.
192 Merrick Road Rockville Centre, L. I.
"RADIO SERVICE" SPECIALISTS
Phone R. V. C. 701

Name Phone

Address Date

..... Time

Kind of Set Tubes Parts

Present Trouble Material

..... Labor

Service Man Tot.

This set now operates to my entire satisfaction.

Signature.....

A card useful to the Service Man, among other purposes, to lead up to collecting for the job.

If he agrees to allow you to inspect his set, make an appointment and KEEP it.

If not, continue, and say:

"Well, Mr. Brown, I am glad to hear that your radio is working satisfactorily and, so that you will know where to call, I am going to mail you my telephone number and address." Experience has shown that twenty-five telephone calls will net, on an average, eight inspections; and, of these eight customers there should be no difficulty in selling four of them at least some tubes or other accessories.

Keep After It

Don't be afraid to do a little extra work. It won't be necessary after your business has come to the point where you have enough daily calls to keep you busy. But, until then, keep right at your promotional work. You can't make money sitting around the shop looking at the four walls, but you can build for the future if you keep constantly plugging at your promotional work.

The next day after your phone conversation, mail your prospect a card or letter telling him your story all over, giving your telephone number. Follow this up with a second letter, impressing him with the desirability of having his radio checked before it really gives trouble. Sell him the idea of having his set put in good shape before trouble really develops and denies him his radio for a few days. Stress the idea that "An ounce of prevention is worth a pound of cure."

While these letters will not give immediate results, they are doing their bit to sell your customer the idea of calling you the next time he needs service. After the second letter, two weeks later, mail your customer a post card, giving him a reminder that you are still waiting to serve him. Continue this card system at least once a month. Call the people on the phone regularly until they get to know you. Remember, too, that before you entered the business they were having their radio taken care of by someone else,

MRS. MARY SMITH,
Baldwin Place,
Oceanside, L. I.

Dear Mrs. Smith:

A Stradivarius violin worth twenty thousand dollars is musically valueless without a little ten-cent chunk of rosin to rub on the strings. A Rolls-Royce costing sixteen thousand dollars won't budge an inch without six little spark plugs costing seventy-five cents a piece.

So you see, when you stop to think about it, the little things are tremendously important. Which brings us to our subject: Is your Radio working satisfactorily—or is it just working? Why be satisfied with anything short of perfect Radio reception when it is so easy to get the best out of your Radio?

Just call Rockville Centre 701. One of our highly skilled Radio experts will call at your home and inspect your Radio, test the tubes, check the installation, all FREE OF CHARGE. Why not take advantage of this offer? You owe it to yourself and your family to see that your Radio is giving the satisfaction it is designed to give. Why let some minor accessory cheat you out of this real Radio enjoyment? Don't delay. Take advantage of this offer. We await your call.

Yours for Radio enjoyment,
GRAHAM BROS.

Another brief, pithy service sales letter.

Dear Mr. Jones:

Is your radio working satisfactorily—or is it just working—?

Perhaps you have been using your radio for the past six months or so without having it checked. It may be that just a tube or some minor accessory is standing between you and complete radio enjoyment.

No matter what radio receiving set you own—no matter if it is be electrically or battery operated—no matter if it be old or new, your receiver does require attention. Perhaps we can be of service to you; and we will appreciate your consideration.

"Those Serve Best who serve with sufficient knowledge and sincerity of purpose." We are radio service specialists with sufficient knowledge and sincerity of purpose to insure you of complete radio satisfaction. We deal in radio facts instead of radio promises and hopes. We are capable radio engineers and our radio knowledge is at your disposal.

Let us look out for your radio interests. Call Rockville Center 701. Our inspection and advice cost you nothing. Why not call now and have your radio set inspected before trouble develops?

At your service,
GRAHAM BROS.

An introductory letter, such as Mr. Graham used in his "get-acquainted" campaign.

it is your job to sell them the idea of calling you.

Do not make it a practice to use price as he bait, use reliability and promptness as your main selling points. Ask your old customers for the names of their friends and follow these names up in the same manner except that you can mention the friends' name and in that way make the conversation more personal.

Your follow-up letters and cards can be cheaply mimeographed and, if you send out twenty-five pieces of mail a day, you will be able to keep at it. This system is much better than mailing a broadside of, say, a thousand pieces of mail once, and then forgetting about it. Make this follow-up system a religion.

After you have serviced a set for one of your customers send them a thank-you letter, emphasizing the fact that you are interested in their well-being from a Radio standpoint. Make them feel that you are interested in *them*, not only in their money. Make your contacts serve you by showing the people that you are conscientious.

How to Sell New Tubes

A very good method that has been used with considerable success in following up these free inspection calls—and regular service calls for that matter—is to have your service kit, tools, etc., in a suitcase large enough to hold the test kit, tools and at least a set of tubes for the particular type of receiver you are servicing at the time. When you are in the customer's home, ask them how long they have had the machine, what previous trouble they have had, etc.; this will give you a general idea of just what may be wrong.

The first thing to do is to examine the machine in its present condition. Proceed to take the customer's tubes out of the set, and place them to one side; then insert the full new set of tubes, explaining to your customer that you always check the set with your own tubes; as this saves time and trouble

in case a tube should burn out during the testing. After you have tested the machine and rectified any difficulties that may have been present, take your tube tester and test the customer's tubes, carefully noting any that may be weak.

Now, with your own tubes in the set, tune in one of the weaker stations; and then remove your tubes, one by one, replacing them with the customer's tubes. If he has any weak tubes, he will immediately see that there is a difference in results with good tubes in the set; and the task of selling him new tubes will be much lighter. Remember that the manufacturer designed the set to work with perfect tubes and it is your duty to see that the set has just that; your customer will thank you after he sees the difference in results. As ninety per cent. of the radio public have been sold on the idea that tubes are the most important part of a radio, you can capitalize the idea and make it pay you handsome dividends.

The practice of having the tubes with you will save you many a sale; because sometimes, while you are running back to the store, the customer gets a chance to change his mind, and may decide to run the set just as it is. Get the job done as quickly as possible and cash in on the interest the customer has in his set at the moment. Later on, something else will captivate his attention; remember the old adage of chain and department stores—"They never come back." Very few of the customers, who say they

(Continued on page 299)

Dear Radio Owner:

We are reminded of a story told about the late P. T. Barnum, the famous circus magnate and practical joker. It seems that, while he was giving one of his shows in the rural sections of the country, Mr. Barnum decided to add a "FREE" attraction to his already famous circus. This attraction was a highly decorated doorway marked, "FREE EXIT." When our country friend entered the doorway and passed through, he found himself outside the grounds and was faced with the necessity of paying another admission to re-enter the grounds to see the show.

FREE RADIO SERVICE is usually worth just what is asked for it—nothing. Many of the residents of this and other suburban localities purchase their Radios from large chain stores located in nearby cities. These large Radio outlets advertise FREE SERVICE.

Out of fairness to the large stores, we must remember that the largest portion of their customers are located in the big cities near to the stores. To these customers the big stores do give prompt, efficient service; but what happens to the service calls from the suburban towns?

Put yourself in the place of one of these big stores. Close at hand you have 90 per cent. of your service work; the other 10 per cent. is spread throughout a circle a hundred miles in diameter. To do one service call in the suburbs takes as much time as to do ten calls nearby. What is the natural consequence of this condition? The suburbanite has to wait until the service department has enough calls out his way to warrant sending a man to his locality.

To YOU, a suburbanite, this means waiting days—sometimes weeks, for service, and the most expensive Radio is useless unless it is giving entertainment—that's what you bought it for. It is not necessary to wait for service.

Yours for complete Radio enjoyment,
GRAHAM BROS.

A sales letter urging the value of prompt service when it is wanted.

Servicing the Brunswick "S-14" and "S-21"

Some practical hints on trouble-shooting these well-known screen-grid models

By HAROLD WEILER

THIS receiver (the "S," or screen-grid line) consists of three stages of tuned radio-frequency amplification, a linear power detector, one stage of resistance-coupled audio (this method is used in the first stage to lessen the possibility of hum by induction and also cut down detector tube hum), and a push-pull power output stage. Stability is obtained by the use of localized shielding and an individual ground for each rotor section of the condenser gang; volume is controlled by increasing or decreasing the screen-grid voltage on the first and second R.F. tubes.

If the volume control R1 appears shorted, do not be too quick in condemning the 0.1-mf. condenser (C3) across it; first take off the volume control and see that the two washers really insulate. Look for this trouble, if there is very little or no screen-grid voltage on the first two R.F. stages. If it still is shorted after eliminating this possible cause, check the volume control itself; the value is 3,000 ohms.

When this receiver does not respond to the high wavelength (or low frequency, as the dial is calibrated in kilocycles) stations, and to the others only weakly, turn the "local-distance" switch to the "distance" side and touch the control grid with the finger. If the signal increases the trouble is either an open or a burnt-out antenna loading coil; this, when the set is on its back, is directly behind the antenna post. Look and see if the wire from this coil to the antenna coupler is broken; if not, the remedy is to replace the loading coil.

Oscillation in this receiver can be usually traced to an open in either C1, C3 or C4; the fault will be usually found in C1, the large tubular condenser next to the terminal strip in the R.F. section of the chassis.

Tracing the Resistors

No plate voltage on the detector is due to a shorted .001-mf. condenser (C12) from cathode to plate, or an open coupling resistor. The latter, found in the right hand corner of the power pack (back facing you) is colored white and rated 125,000 ohms. This resistor (R7) will show continuity when tested with the ohmmeter; but will open when the detector plate current is passing through it. Low detector voltage is usually caused by a leaky .001-mf. condenser.

No grid bias on the R.F. tubes is due to C2 being shorted; or else the 100-ohm wire-wound resistor R3, on the terminal strip in the radio end, is shorted. Low grid bias is due to a partial short of this resistor.

No grid bias on the first audio tube is due to a short in C8 or in the 2000-ohm (pink) resistor R8. Low grid bias is due to a partial short.

Absence of grid bias on the '45 may be due to a shorted 800-ohm (brown) resistor R11. Lack of any voltages, either filament or plate, can be laid to open primary or to a bad Durasite (voltage-regulator) tube. This tube is very sensitive to knocks and jars; the standard size is the 110; if the voltage is high, use a 105; if it is exceptionally high, use a 98.

After this discussion of the most common causes for hum in this "S" chassis, some values will be given.

Causes of Hum

A shorted variable condenser section (although this is quite a rarity) can be easily found with an ohmmeter, such as that described in Mr. Tantlinger's article in the May issue of RADIO-CRAFT on page 564; the resistance of the grid coil is four ohms. Absence of signals, with the ballast lamp abnormally lit, simply cries aloud "Short!" This can be localized by taking out the speaker field plug. If the ballast lamp retains the same brilliancy, we can eliminate the R.F. end and the first A.F. plate circuit. Now let us test for a short in C5 or C6, from the plate of the '45 tube near the rectifier, to the black wire going to the center tap of the '45 hum balancer R12. If we have traced thus far in the power unit without eliminating the hum, this is the last and only common cause for a short and, luckily, it usually makes its presence known by an overflow of tar from the choke container. This indication of a short is due to the heat of the choke, melting the tar and the weight of the choke forcing it downward until the laminations touch the terminal strip underneath.

If taking out the speaker field does reduce the brilliancy of the ballast lamp, the short lies in either C1 in the radio end of the chassis, or in the condenser block in the unit leading to the speaker field and terminal 3. The value is 1 mf.

(Continued on page 301)

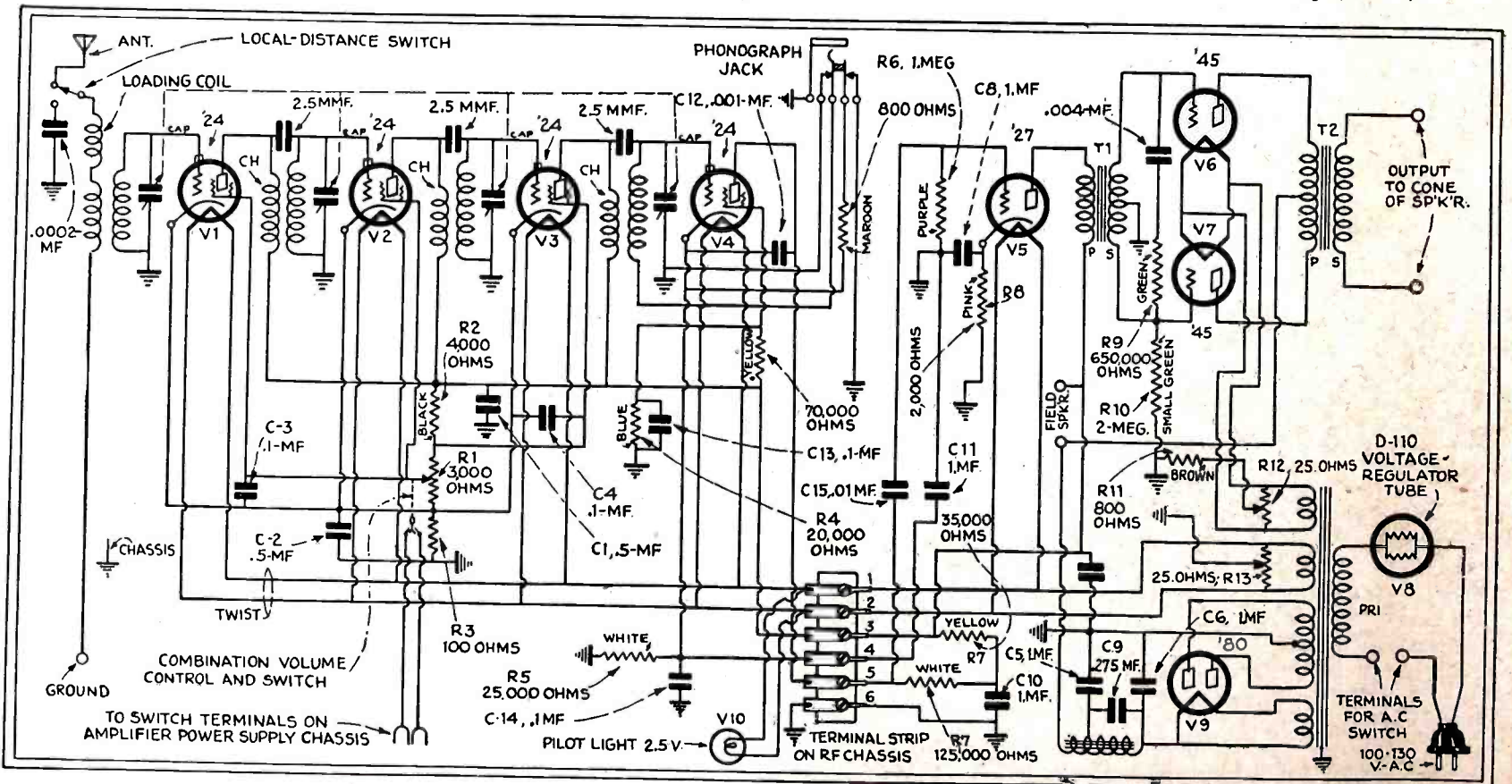

Fig. 1

At the left, the chassis of the tuning unit; at the right, the power pack, including the audio amplifier, of the Brunswick "S-14" and "S-21" screen-grid models. Points to be watched are discussed in the article; a good-sized condenser from the speaker field tip-jack to ground may do away with persistent hum.

Modernizing The Old Radio Sets

A few tips for the Service Man whose customer wants more volume

AN ADDED A.F. STAGE FOR D.C. SETS

By Alex. Vergas

RECENTLY a certain dealer called the writer to service an R.C.A. "Model 18" D.C. set combined with a mechanical phonograph.

Upon arrival I found the connections to the external 22½-volt "C" battery disconnected and, instead of '12A tubes throughout and a '71A in the last audio, two '01A tubes were found in the R.F. and a '71A in the first and second audio. The instrument functioned as well as possible after

value is preferable; for the reason that excessive voltage will burn out the filaments readily and it is better to be on the safe side. The difference is hardly detectable by ear.

Changing Over the Chassis

Although the amplifier is adaptable to any type of D.C. radio set, there must be variations in different installations. In Radiolas 18, 33, and 51, it is necessary to make the changes indicated at X in Fig. 1A.

First, unsolder the lead to the plate of the first A.F. tube socket and the "B+"

wire going to the primary, from the second audio transformer T1. Tape these ends and put them out of the way. Now, in their place solder a pair of wires (twisted) about two feet in length (or more, depending on the distance of the amplifier from the set) and connect them to the two binding posts leading to the primary of the input transformer T3 (as shown in dotted lines).

Next, cut the grid return of the same unit (T1) and tape it; this also applies to the "B+" lead to the primary of output transformer T2. This completes alterations on the chassis. The power box remains intact. Do not touch the filament wires of the '71A tube socket or take the tube out (for the tubes of these sets are wired in series); do not short it, as that would increase the voltage applied to the remaining tubes.

To those who wish to take the '71A tube completely out, however, it may be pointed out that this can be done after soldering a wire-wound resistor of about 20 ohms across the "F" terminals of that socket.

The layout followed in constructing this particular amplifier is shown in Fig. 2.

List of Parts

- One 150-turn honeycomb coil (for filtering);
- One audio filter choke (made by winding about ½ lb. No. 18 D.C.C. wire on an old transformer core);
- Two ¼-meg. leaks, Tobe;
- One .0005-mf. fixed condenser, Dubilier;
- Two Benjamin UX sockets;
- Two porcelain screw-base lamp sockets;
- One Amertran push-pull A.F. input transformer, T3;
- One electric outlet;
- Two fuse receptacles and 10 amp. fuses;
- Five binding posts;
- One 2-mf. Tobe by-pass condenser.

IMPROVING THE RADIOLA "SUPER"

By Ralph W. Luce

AN "AR-812" Radiola Superheterodyne may be sufficiently modernized to operate a dynamic speaker by adding a '71A (Continued on page 302)

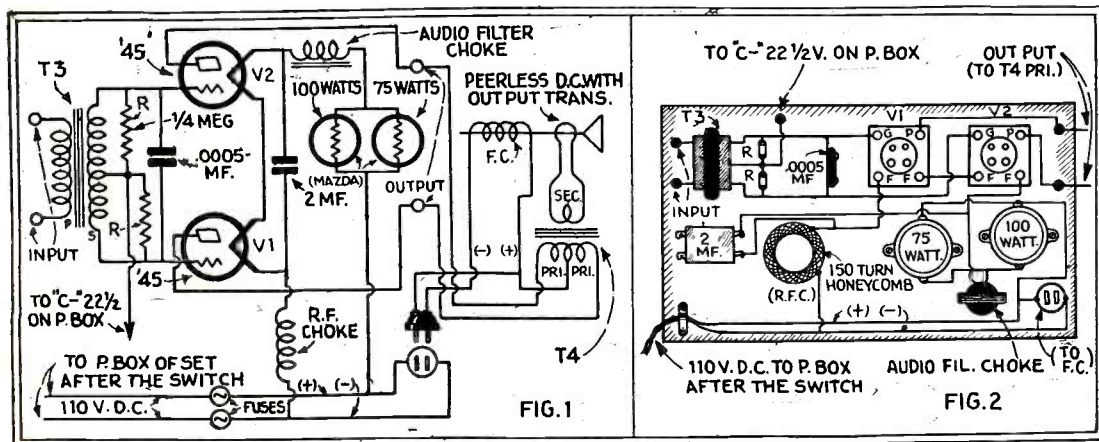

In order to use more effectively the limited plate voltage, Mr. Vergas replaces the '71A output stage of a D.C. Radiola with push-pull '45s, externally. The layout is shown at the right.

the proper tubes were inserted in the respective sockets; but it still lacked real "pep."

After the job had reached this stage, the customer asked whether there was any way possible to bring the set up-to-date by using a dynamic speaker and an electric phono pickup. Before answering this question I took into consideration the fact that this man had a critical ear for music and would no doubt be hard to please.

The following day I purchased a Peerless D.C. 7-inch dynamic speaker and a Gordon pickup with volume control combined, with the necessary hardware; which included a S.P.S.T. switch to be used as a transfer switch.

After installing the speaker and pickup in the cabinet, I encountered the most difficult feature of the job. When I had the switch and the pickup into the circuit and disconnected the output transformer from the set to use the output transformer of the dynamic speaker, I found the set did not have enough "kick." Also (which was worse, in this case), the pickup was barely audible.

It was finally decided to make up a separate audio amplifier comprising two type '45 tubes in push-pull. The schematic circuit followed in building this amplifier is given in Fig. 1.

Two type '45 tubes, filaments in series, consume 1.5 amps. at five volts. A seventy-ohm resistor would supply this current; but it was more convenient to use a 100-watt and a 75-watt Mazda lamp in parallel. These are cheaper and more conveniently replaceable than the usual resistor used here.

After the amplifier was constructed and tested, it was found that the filaments of the '45 were getting 2.35 volts each. This

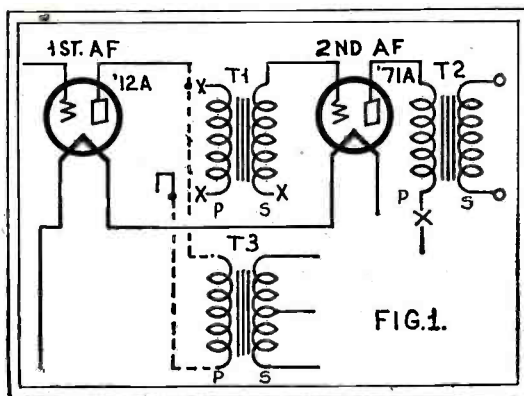

Fig. 1A

The internal changes shown above must be made on the Radiola "18" ("33," "51") to add the external power stage shown above.

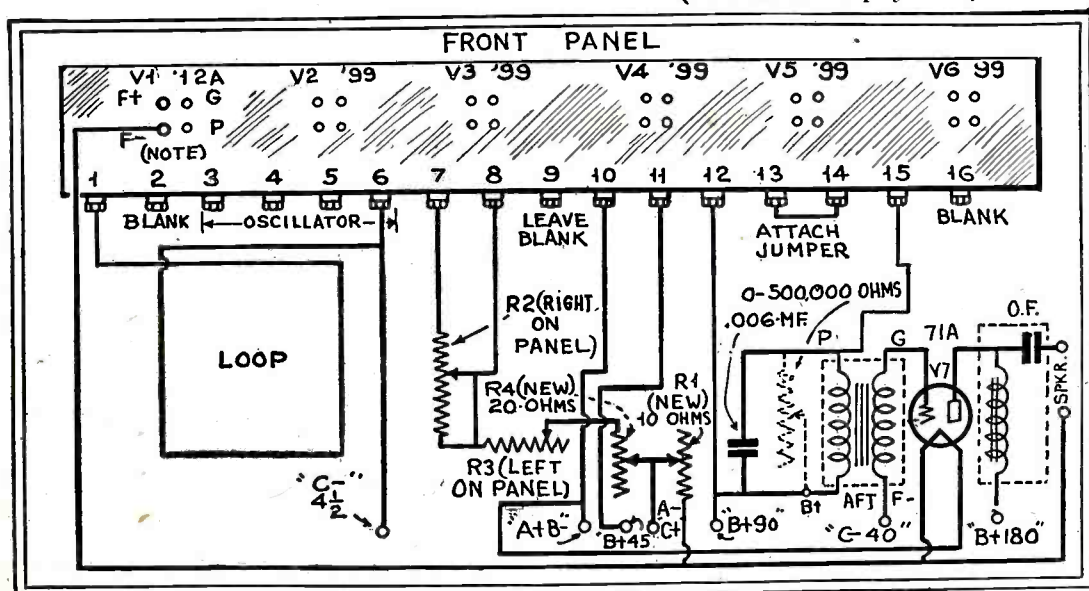

Fig. 3

Lieut. Luce disconnects the "F" prong of V1 to use a '12A instead of a '99 here (this is optional) in remodeling the "AR-812," for operation with an added '71A amplifier from a "B" power unit.

And Now--- the "Midget" Radio Set

*A new type of receiver for
a special purpose*

TO meet the considerable demand for a compact radio set, which will be in keeping with the surroundings in many homes and apartments, and suited to present economic conditions, there have been developed by a number of radio companies set designs, both efficient and compact, which house modern electric receivers in very small cabinets.

Examples of this development are shown in the accompanying illustration of three such sets, made by The Crosley Radio Corporation, Cincinnati, Ohio, the Jackson-Bell Co., Los Angeles, Calif., and the Simplex Radio Co., Sandusky, Ohio.

Although a great number of standard receivers of the larger dimensions to which we have become accustomed are in use at the present time, it has been realized that there are a number of nooks and corners throughout the average residence where another little set would be most welcome. The mantel, for instance, often is a convenient place for a light-weight radio set; hence the origin of "Mantelpiece" as a receiver style designation.

A forerunner of the "midget" radio set was the type of lowboy, recently introduced, where the designer has arranged the controls for easy operation from a very low chair. But much greater ingenuity was necessary to accommodate a workable radio set, comparable to the larger sets in performance, in the dimensions of a cabinet that resembles a mantel-clock.

Little vs. Big Sets

The first question that these sets arouse is: "If these midgets are as efficient as the big cabinet jobs, why buy the big sets?"

Well, in the first place, it is not possible



Upper right, the Crosley "Model 54" the circuit of which is shown below; upper left, the Simplex "Model H;" below, the Jackson-Bell "Model 62," the schematic diagram of which is at the top of the opposite page. All three are screen-grid sets with '45 power amplifiers and speakers, housed compactly in the small cabinets shown.

to get something for nothing; and we find upon investigation that these sets are out of place in many large rooms, where the beautifully-carved cabinets of the large consoles will afford a perfect match with the surroundings. Again, an inspection of the circuits of these sets (two of which appear in this article) discloses that there are a limited number of tubes, and these are worked at the limit of their capacity. The standard consoles embody R.F., A.F., and power chasses that are more sensitive and

powerful in operation. On the other hand, these little sets contain more amplification and give greater output than the best distance-getters of a few years ago; and in many locations will probably develop all the possibilities of reception available.

None of the midget sets here pictured uses more than a single tube in the last stage of A.F.; and in all three receivers the screen-grid detector feeds directly into the one and only stage of A.F. amplification.

(Continued on page 303)

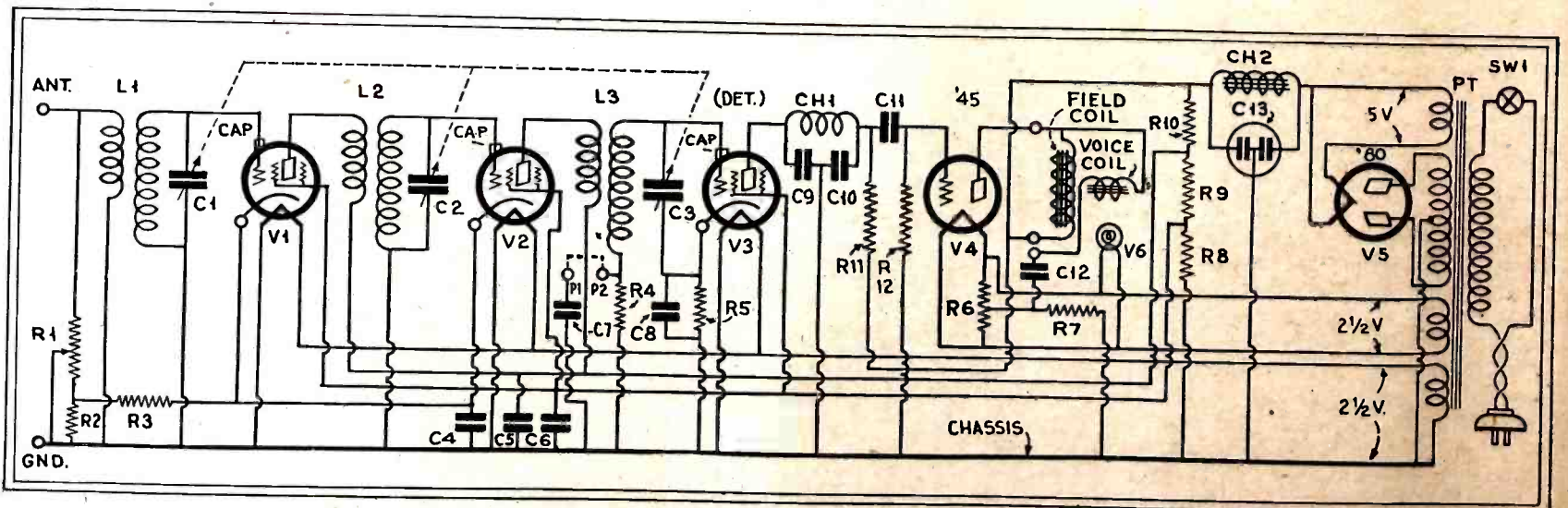

Fig. 1

Circuit of the Crosley "Model 54—New Buddy," illustrated at the upper right corner of the group of midget receivers above. It has three screen-grid tubes—two R.F. stages and detector—feeding into the power tube through a special filter system. The speaker is of a special electromagnetic type. (The pilot lamp shown is used in the similar circuit of the "Model 53.")

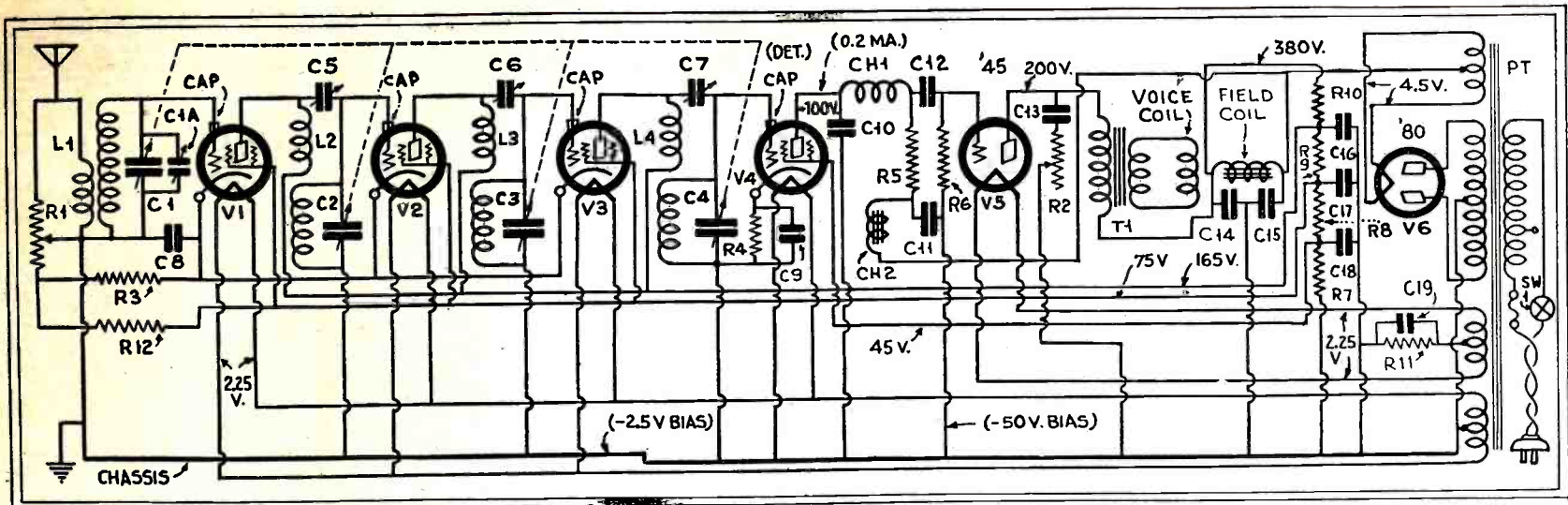

Fig. 2

The schematic circuit of the Jackson-Bell "Model 62" illustrated in the lower half of Fig. A, on page 274. This set embodies three tuned R.F. screen-grid stages before the detector, and a dynamic reproducer. The large filter capacities are provided by dry electrolytic condensers. Values are given on page 304.

A Versatile Unit for All Radio Purposes

THE fundamental similarity of every radio circuit is practically demonstrated in the device illustrated below—a very simple, compact assembly of apparatus which will serve practically every purpose of the experimenter, as well as that of the DX listener; yet which requires only a quick change-over of its external connections to become a short-wave receiver, a short-wave adapter, for either battery or electric sets, a booster unit, a pre-selecting wavetrap, an R.F. oscillator or a wavemeter for broadcast or short-wave work, a practice set for the student of code work, etc., etc. This versatile equipment, well named the "Flexi-Unit," was the conception of George W. Walker, the well-known designer of super-heterodynes and other radio equipment; and his latest model is illustrated here. It is manufactured in very attractive and substantial form, by the Work-Rite Radio Corp., of Cleveland, Ohio.

The case is of cast aluminum, very strong, light, and serving as an effective shield for the tuning condenser. For adaptation to any band between 15 and 550 meters, four UY-base plug-in coils are provided; in the short-wave inductors, the aerial winding runs directly to ground, while in the broadcast coil, it is tapped off on the secondary.

The grid leak and condenser are utilized when the unit is used for short-wave work or as an oscillator, but replaced by a jumper when the tube serves as an R.F. amplifier. Either a '99 or an '01A tube may be used for work from batteries; or a '27 may be employed with an electric receiver, when the "Flexi-Unit" serves as a short-wave adapter.

The eight numbered binding posts of the unit, at the rear of the rugged case, are connected in any manner desired by the user; the internal connections are as shown in Fig. 3. The ground post and the filament-rheostat knob are mounted on the back of the case. At the left is the tube socket, at the right the plug-in coil socket, with the grid condenser and leak between them. The regeneration and aerial-coupling control knobs are in the center, and at the front is the vernier-control dial of the tuning condenser. The strength of the apparatus insures durability, and the workmanship is

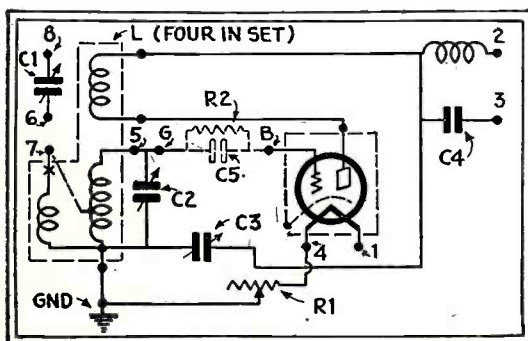

Fig. 3

Fundamental circuit utilized in the "Flexi-Unit" and applied by a few external connections to any of twenty purposes.

excellent. The top panel is 5 x 7½ inches; the height is 2½ inches to top of case; and the weight complete 2¼ pounds.

In addition to the connections and controls visible from the outside, and the set of inductances, the unit comprises the following components (Fig. 3): C1, aerial condenser, 45 mmf.; C2, tuning condenser, 250 mmf.;

C3, regeneration condenser, 100 mmf.; C4, coupling condenser (to antenna post on broadcast receiver), 150 mmf.; R1, filament rheostat, 30 ohms.

Without other accessories than tube, batteries, and phones, and without the need of tools, the unit serves many purposes for the radio worker. However, its full efficiency, and that for which it will be most serviceable, is only obtained in connection with the audio channel of a broadcast receiver. In order to connect it to the set, several models of connectors have been designed. The "No. 01" adapter plug permits the use of the unit as a pre-amplifier, or booster, on long waves, or as a short-wave adapter.

In the latter service, as may be seen from the photograph, it lends itself to especially comfortable tuning from a chair-arm or table-top. The freedom from hand-capacity obtained by the shielding will be appreciated; while the finished appearance of the little control box will not be out of place in the finest parlor, and its base is padded, to protect the surface on which it rests.

With electric sets, the "Flexi-Unit" takes instead the "No. 27" or the "No. 24 S. G." adapters, depending upon the type of tube in use in the receiver; the former is for use as an adapter, and the latter, as a screen-grid booster.

The advanced experimenter, or the Service Man, will quickly see the additional applications of this especially ingenious "multum in parvo" to his daily uses. The quickness with which the connections may be altered, without the use of wrench or iron, will be one of the features to recommend it for his work.



Fig. B

The "Flexi-Unit" with an adapter and cord, such as are provided to connect it to a receiver for any of several purposes. The grid leak and condenser at the rear, just in front of the binding posts, are replaced by a jumper when it is to be used as an amplifier. The case is cast aluminum.

The Development of the Screen-Grid Super

How the four-element tube is utilized most effectively

By W. H. HOLLISTER*

UNTIL a few years ago, while the marvelous possibilities of the superheterodyne were obvious, it failed to find acceptance in the drawing room of the American home because of the practical drawbacks, such as harmonics and regeneration squalls, and a general complexity which relegated it to the experimenter.

The superheterodyne has at last come into its own again, as a result of the careful engineering development work which has been put upon it in the past three years, as well as the production of the screen-grid tube, which makes possible circuits of the highest stability and amplification. A review of the considerations which have led to the creation of the modern superheterodyne, with its extraordinary qualities, may be given briefly.

The untuned transformer is very successful as a coupling device between three-element tubes in low-frequency amplifiers; but at high frequencies (short wavelengths) very little gain can be obtained because of the short-circuiting effect of the input impedance of the tube into which it feeds.

At a frequency of 500 kilocycles, it is possible to get from a tuned circuit an impedance of several hundred thousand ohms, which increases with both the efficiency as well as the inductance of the coil. In the three-electrode tube, with a plate-to-filament resistance of less than 20,000 ohms, it does not require a very large impedance in the primary of the transformer to take a considerable portion of the voltage generated across the primary. This means that very close coupling between the primary and secondary of a tuned secondary transformer is not required.

Enter the Screen-Grid Tube

It is not possible to get all of the gain out of a transformer when used between three-electrode tubes, however; for a condition of instability and tendency to oscillation appears when the gain reaches a certain value per stage. The maximum gain, of course, would be reached with good shielding, by-passing of each stage to eliminate coupling by common impedance, and

neutralizing. There would be no object in using a tuned primary and tuned secondary transformer for coupling three-electrode tubes; because all of the gain obtained, by tuning only the secondary, cannot be used even with perfect shielding and neutralization.

The four-electrode screen-grid tube, however, has radically different properties from the three-electrode tube. The presence of a shield or screening, between the grid and the plate, reduces the coupling capacity between the grid and plate. The screen does not materially change the input or grid-to-

impedance at least equal to the plate-to-filament resistance of the tube.

A tuned secondary transformer, which was satisfactory for the three-electrode tube (having a primary impedance of possibly 50,000 ohms), would give very little gain when used with screen-grid tubes; because of the very small proportion of the total plate-circuit impedance which the primary of the transformer would represent. A tuned primary would, however, have a very high impedance and would make it possible to utilize a larger proportion of the voltage generated in the tube.

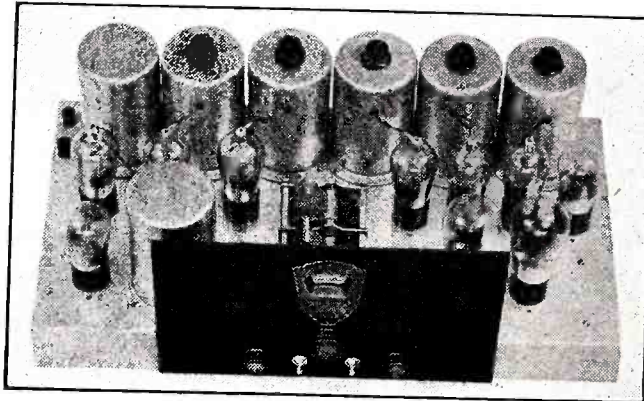

Fig. A
The receiver chassis of the "Model 31," which is designed for housing in a suitable console. The five knobs of the cylindrical shield cans serve to adjust the condensers C1 which tune the intermediate-frequency amplifier.

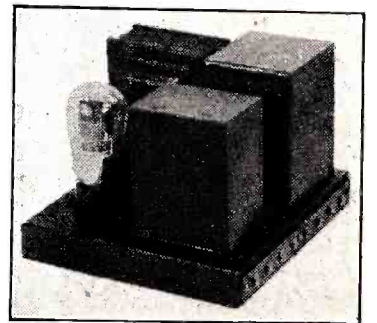

Fig. B
The extremely compact power unit designed for the "Model 31," it may be located where most convenient for all purposes.

filament capacity; but the plate-to-filament capacity is considerably increased.

This means that the short-circuiting effect of the output capacity of a screen-grid tube is several times the short-circuiting effect of its input capacity. Since tuning either the primary or the secondary of a transformer has the effect of removing either the output capacity or the input capacity, respectively, the idea of tuning the primary is immediately suggested.

The effect of the screen is to increase the plate-to-filament resistance from a value of less than 20,000 ohms to one in the order of 500,000 ohms! With the three-electrode tube, it was very difficult to get a primary

The Tuned Primary

It is evident that, if the primary impedance of the transformer is equal to the plate-to-filament resistance of the tube, only one-half of the voltage will appear across the primary. From these considerations, it is easily seen that the primary of a transformer used with screen-grid tubes must be tuned. In this case, the plate-to-filament resistance is so high that its effect upon the tuned primary, in producing an "equivalent series resistance," is negligible. This means that there will be no loss in selectivity in tuning the primary, but a considerable increase in voltage amplification is effected.

(Continued on page 304)

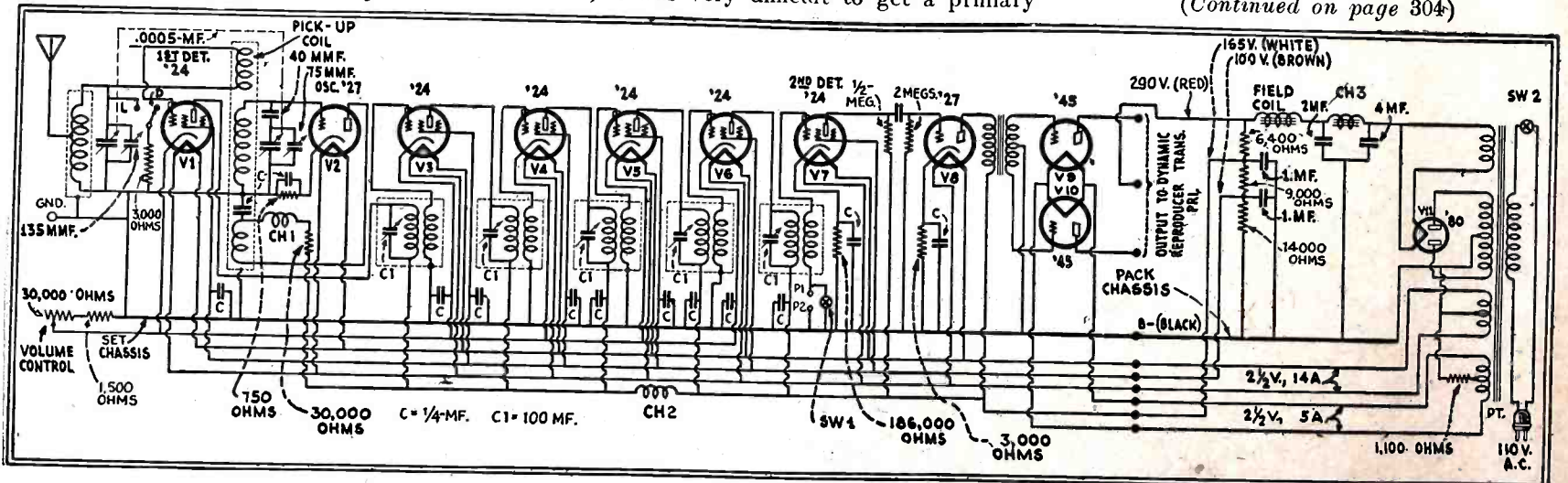
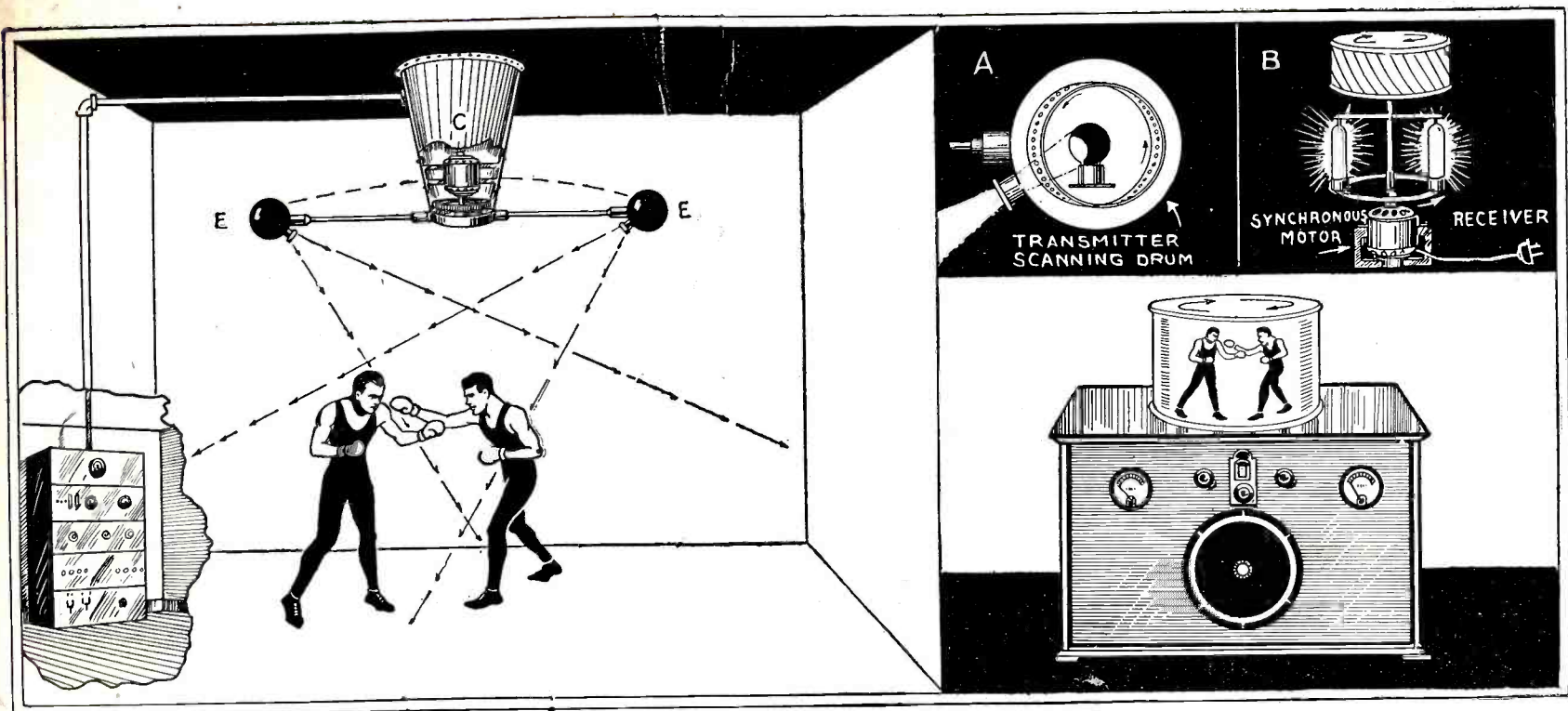

Fig. 1

The heart of every superheterodyne is its intermediate amplifier. The "Model 31" has four screen-grid I.F. stages, with plate windings tuned by the 100-mmf. midget condensers C1. The bypass condensers C are 0.25-mf. P1-P2 are phonograph pickup jacks; and L-D the "local-distance" switch.

* Lincoln Radio Corp.



The Gould system of panoramic or "three-dimensional television:" the transmitter is shown at the left. The synchronous motor C revolves an arm carrying two "electric eyes" E which pick-up the motions of the boxers from all angles in one revolution. Each "eye" contains a photo-cell and a cylindrical scanning drum, as shown at A; the spiral motion is obtained by the rotation of the system. At the receiver, shown at the lower right, the image may be viewed from any side. The vertical drum on the receiver is slotted spirally, as shown above at B; and the two neon lamps, revolving in the opposite direction, combine their red and green lights to give natural colors.

Television Projected in Three Dimensions

WHILE all television images hitherto reproduced have been extremely limited in the angle of vision of the scanning apparatus (if only because the detail of the image was limited for electrical reasons) it will ultimately be desirable to present moving scenes of considerable size. An interesting system of viewing localized action from all sides has been worked out by Leslie Gould, the Bridgeport, Conn., inventor, whose system of colored television was described in the July, 1930, issue of RADIO-CRAFT (page 24). The ingenious method proposed is illustrated here as it would be applied to the televising of a boxing match, to which it seems especially suited.

Above the principals is shown a cone C, containing a synchronous motor which ro-

tates a horizontal rod, on each end of which is mounted a scanning device E. This "electric eye," as shown in the detail sketch (A) at the upper right, contains a photoelectric cell, surrounded by a scanning drum, which passes the light rays from the scene below, point by point in a vertical line, to the sensitive surface of the cell. The result, it will be seen, is that the moving figures within the range of the photoelectric cells are scanned spirally, from every direction, in the course of one rotation of the rod. It is possible, of course, to use more than two electric eyes; but a separate channel or waveband is required for each transmission.

At the receiving end, the reproducer used will be composed of a radio receiver and a rotating vertical drum, inside which are

mounted two neon tubes, as shown at (B) in the upper right corner. One of the tubes gives out red light, and the other green, corresponding to the two pickups at the transmitter. The combination of the two colors approaches the natural light-values of the scene.

Since the neon tubes revolve in one direction, and the diagonal slots in the other, the reproduced image is also scanned spirally; and the result is that we have, as shown at the lower right, a television image which may be seen from several angles; standing out, as it were, in the round. The effect described by the inventor is that of viewing the ring from any desired angle, just as if it were reduced to the compass of the outer scanning drum of the television reproducer.

A New Self-Contained Television Reproducer

By GEORGE WALD

NO matter how perfect a motor-synchronized scanning disc may be made, in the writer's opinion it will never be a success in the home. The housewife desires an apparatus whereby she can turn on a switch and tune in a station; then "look and listen." Any other manipulation of devices is destined to failure.

The writer, after consideration of the problems, was led to invent a television apparatus for the transmission and reception of images without the use of any mechanical scanning device; and U. S. patent 1,754,491 has been issued for its basic ideas.

As shown in Fig. 1, the receiving tube, when seen end on, presents a screen of anode and cathode wires, crossing at right angles, and establishing the elemental points

SCANNING DISCS, driven by S motors, while necessary in present television work, are admittedly crude and unsatisfactory. The cathode tube, which has been used with some success in the laboratory, has requirements not suited to the home. Lieut. Wald, a U. S. army officer, stationed at Selfridge Field, has just patented another method of scanning by electricity, without the use of moving parts, which depends on the fact that voltage waves are continually moving up and down an A.C. transformer.

The principal features of the method are here described, with reference to the patent drawings.

of the televised image to be reproduced. Each of these wires is connected to one tap of a secondary (12, 16, Fig. 2); and variable frequencies are applied to these secondary coils. As the currents in the secondaries set up a varying voltage at each tap, there is a maximum difference of potential at the intersection of only one pair of wires at any instant; and at this point the discharge between the anode and the cathode produces one bright point on the image screen.

As each variable-frequency train sweeps over the row of cathodes, the bright point on the screen moves and produces a line; and as each train of frequencies passes over the row of anodes, the entire frame of the

(Continued on page 306)

The New "Times Square" Studio of the N. B. C.

A peep behind the scenes of broadcasting, showing the enormously elaborate nature of the equipment required to insure that chain programs are put "on the air" smoothly and without delay

By C. A. RACKEY † and R. M. MORRIS ‡

A MODERN broadcasting studio is primarily a workshop and has been designed accordingly. The disposition of artists, instruments, pick-up and control devices and other paraphernalia is such as to leave but limited space for a guest audience. Besides this, there is the problem of change of acoustical state of the studio space where a considerable mass of sound-absorbing material (such as human bodies) has been introduced. Irregularities in the matter of variations from the program balance determined during a rehearsal to that obtained during the actual presentation of a program, with a considerable guest audience added, have been experienced. Special precautions on the part of a trained studio staff must be taken in this regard.

To provide a studio, therefore, to accommodate a larger guest audience and one in which the operation of producing radio entertainment should be fully visible, with no uncontrollable factors introduced, the Times Square Studio of the National Broadcasting Co. was conceived and a specially-constructed auditorium atop the New Amsterdam Theatre in New York has been adapted to the purpose. Investigation was made of the technical considerations involved, and an installation designed accordingly.

Numerous Microphones Needed
Twenty-six condenser microphone "outlets" or positions were installed in various parts of the house. These were placed along the footlights, in the orchestra pit, up in the

"fly-loft," the wings, at the balcony rail, and in the auditorium ceiling, to afford any sort of pickup that may be necessary to a particular production.

The outlet circuits are led to a panel on

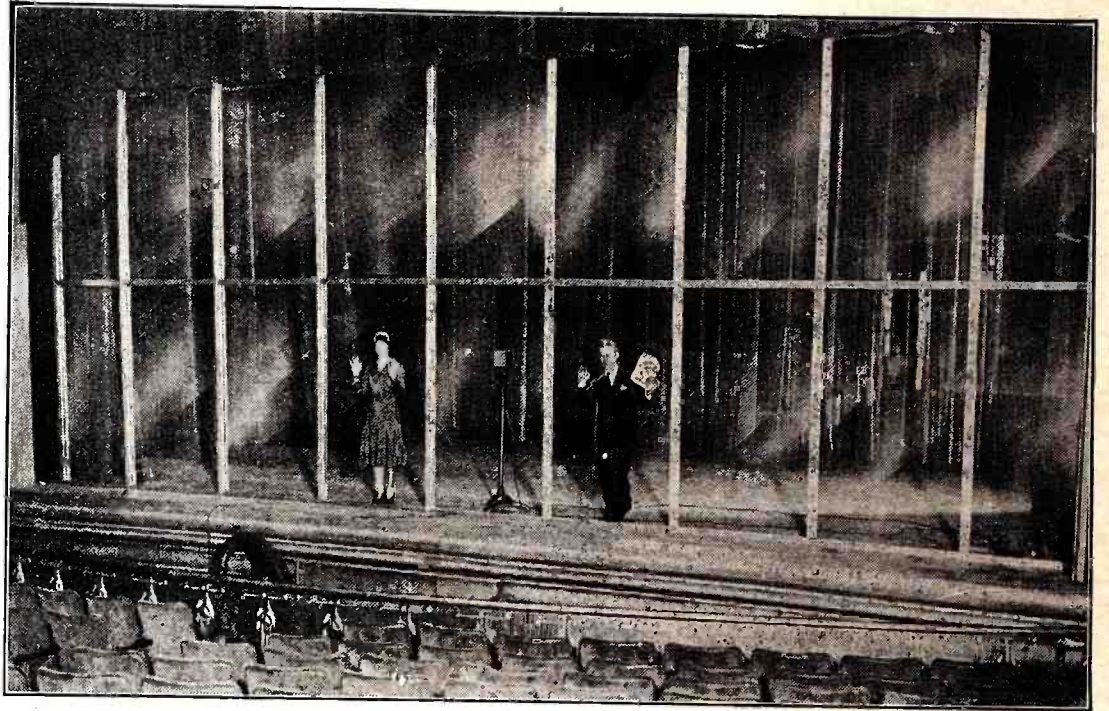

Fig. A (above)

The six-ton glass curtain which cuts off the stage from the audience while programs are being broadcast, and prevents outside noises from being picked up by the stage microphones; the audience, watching the artists, hears them, not directly, but through reproducers which are connected into the amplifiers through the "gain control," as shown in Fig. 1. With curtain raised, the program may be picked up by microphones in the pit, which also record audience sounds.

Fig. B (left)

The control board and the gain-control operator's desk at the Times Square studio. The desk at the right is in front of a double-glassed observation window, through which the operator is watching the performance below him on the stage, as well as the audience in front, while he "monitors" the amplified program.

the control board, from whence they may be "patched" or connected into a "mixer"; the output of which is then amplified and monitored in the usual manner and transmitted over a telephone line to the main control room of the N. B. C. at 711 Fifth Avenue.

A booth, located high above the stage, at the rear of the house and affording a good view of both the stage and the house, was transformed into a control and monitoring room. A speech-input control board and a power-supply switchboard were installed therein and the room acoustically treated. The gain-control operator's position is at a small control desk in front of a double-glassed observation window through which he can keep in sight the entire proceedings below him.

Isolating the Stage Sounds

A special feature on the stage is the glass curtain which can be lowered to isolate the performers on the stage proper from the audience. This curtain is made of large rectangles of plate glass set in a steel frame or grille. The entire assembly weighs six tons and has an average sound attenuation of twenty-five decibels.* Whenever this curtain is lowered, the audience hears the program through loud speakers located in the orchestra pit; which are operated from amplifiers bridged across the return monitoring amplifiers as shown at the lower left in the accompanying circuit layout (Fig. 1).

* See note at end of article.



† Design Engineer, N. B. C. ‡ Development Engineer, N. B. C.

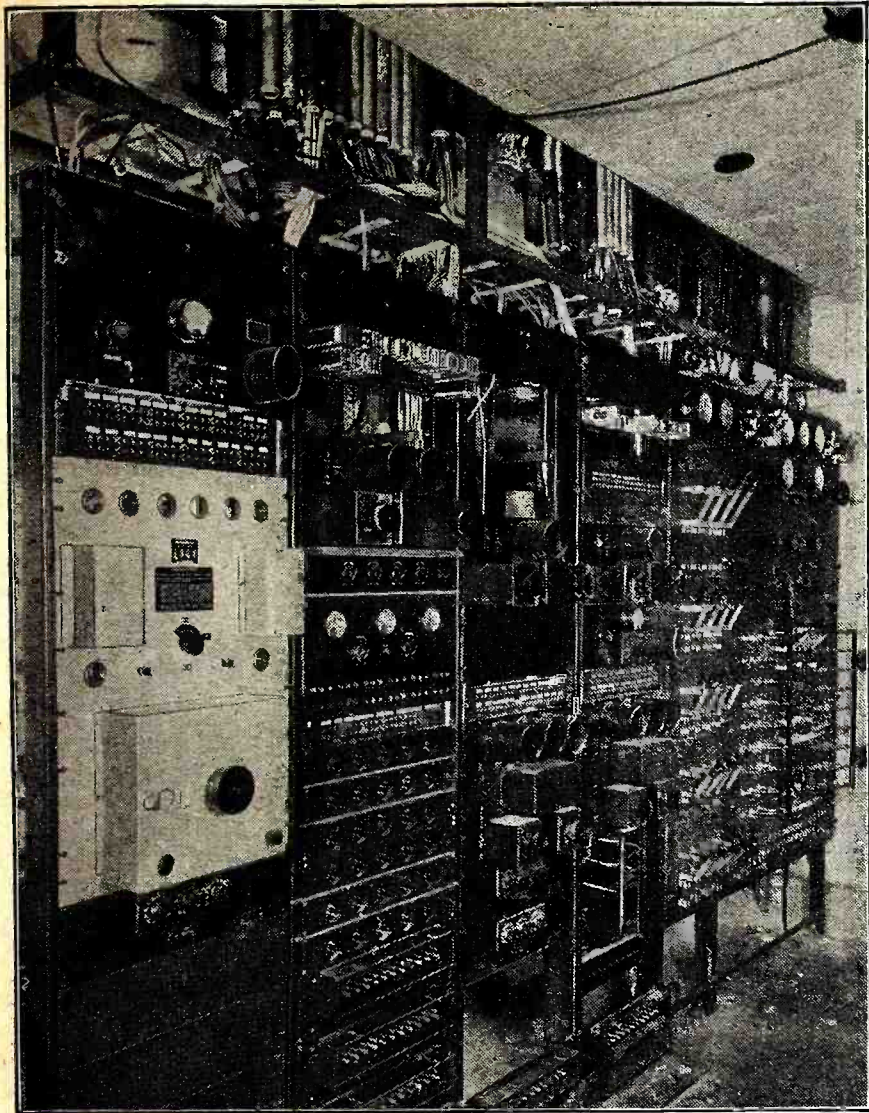

Fig. C
The speech-input control board and the power-supply switch-board, of the Times Square studio of the National Broadcasting Company, photographed during its installation in the New Amsterdam Theatre, at Broadway and Forty-Second St., New York City. An idea of the elaborate nature of the equipment shown in schematic form in the diagram below will be gained from this picture. (The cylinders protruding from the front of the panels are protectors for vacuum tubes, mounted thus horizontally for quick replacement.) The apparatus is ready in complete duplicate for every part; so that a failure can not cause more than an instant's delay.

Fig. 1 (below)
This diagram shows merely the order of the complicated units, housed in part in the panel illustrated above, through which the pick-ups of the numerous microphones are blended.

An advantage of operating with the curtain lowered, beside that of isolation from the audience, is that soft-voiced dialogue, crooners, "whispering" baritones and the like may be heard at proper volume in the house; whereas, if the curtain were raised, the actual sound itself, though sufficient to actuate the sensitive microphone, would be but poorly distinguishable by the audience.

The studio can also be operated with the curtain raised, and it has been so used on several occasions. When the curtain is out of the way, the artists play as to an audience, in the regular manner of theatrical presentations; and sound-concentrating pickup devices, located out in the house above the audience and facing the stage are employed to pick up the program. Microphones out in the house are also used to pick up room noise and applause, when this is desired.

The use of sound concentrators or directional pickup devices solves many of the problems of acoustical interference and program balance. Properly employed, they give the reproduction a definition, and at the same time a blending, that can rarely be achieved by other means.

The inclusion of all the various types of microphone pickups in the Times Square Studio is in accordance with the plan to make it a very flexible installation.

The Announcer's Pulpit

An announcer's control stand or "pulpit" located on the stage, contains, besides the announcer's microphone, the necessary controls for connecting in either the announcer's or the program microphones. It also provides the announcer with signal lights ("stand-by" and "go-ahead") and jacks by means of

a loud speaker on the stage and also makes inoperative the local monitoring speakers to prevent acoustic feedback.

Local and Remote Controls

On the speech-input control board up in the booth are mounted the microphone and line amplifiers, condenser microphone, power supply panels, volume indicators, power amplifier to operate the pit loud speakers, an audio oscillator and associated testing apparatus and the various circuit switch terminations. A spare unit which can be cut in immediately, in an emergency, is provided for every piece of apparatus in the program line-up. Spare condenser microphones are always set up, needing only to be "faded in" to supplant a defective one which is simultaneously "faded out."

Two 14-volt banks of storage cells for vacuum-tube filament lighting, and two 402-volt banks of storage cells for high-voltage plate supply, are located in a battery room under the stage. The power board to control charge and discharge is located adjacent to the speech-input control board in the booth.

At the volume-control operator's desk are located a six-position mixer, a main and a vernier gain control, an "interphone" and an order wire connecting with the Fifth Avenue control room, a volume indicator and the switching keys for signaling the announcer.

An interesting condition, mainly psychological, was apparent during the tryouts of this studio. It was found that the difference in volume between the dialogue, the announcements, and the spoken programs in general

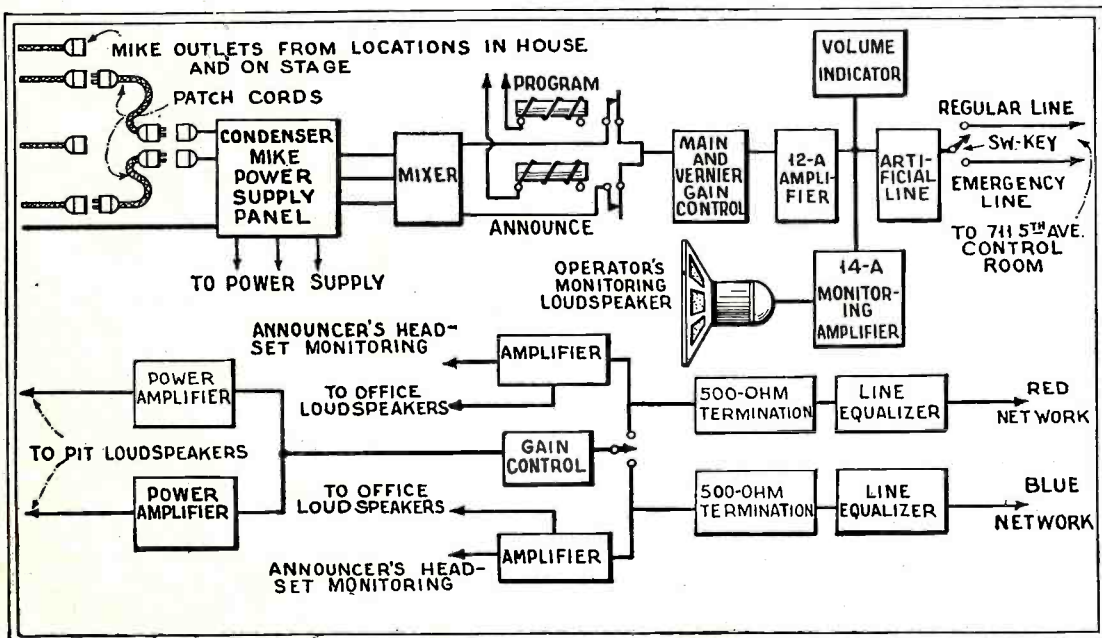

which he can monitor, with a pair of headphones, any of the N. B. C. programs passing through the Fifth Avenue control room. This is necessary for the synchronization of the various networks.

The "pulpit" is semi-portable and its circuits are terminated at the end of a flexible cable, which may be plugged in at several locations about the stage to suit whatever setup is used.

Between the control room and the stage is provided a "studio address" system by means of which a director in the booth can talk back to the stage during rehearsals. A button on a microphone stand up in the booth, when pressed, connects the microphone to

and that of the musical programs (especially with large orchestras as heard through the loud speakers with the glass curtain lowered) was unsatisfactory. The sight of the physically large ensemble of instruments made it necessary to satisfy expectations by bringing up the volume much above that of the spoken dialogue; the fact being, of course, that since the spoken dialogue had been increased in volume, beyond the natural case, the orchestra volume had to be increased proportionately. This necessitated a separate volume control on the pit loud speakers; it is controlled by an operator located out in the audience on the balcony.

(Continued on page 305)

New Applications of Radio Principles

Ingenious Devices embodying standard electronic tubes, and some tubes that are of novel types

THE versatility of the photoelectric tube is being daily demonstrated; it seems that there is hardly a function accomplished by the guidance of the human eye which cannot be more accurately and quickly performed by this simple little device, in connection with suitable vacuum-tube amplifiers and relays to operate machinery. It thus serves for delicate sorting, numbering and color-separation activities; and has taken its place in many forms of industrial operations.

An ingenious use of the photo-cell, lately found by the engineers who are seeking jobs for the "electric eye" to perform, is illustrated on the cover of this issue of RADIO-CRAFT and in Figs. A and B on the opposite page. The door which the waitress is entering has been opened for her by no human hand, but by the mechanical appliance which is connected to the lever at the upper left of the door. As indicated by the dotted line in Fig. B, an electric lamp (right) throws a steady beam into a photoelectric cell which is encased in the little cylinder at the left. (As a matter of fact, these are, for operating purposes, placed on the opposite side of the door, to open it for a person approaching from that direction.) As soon as the beam of light is interrupted by the passage of any body, the drop of current through the cell operates a relay; and the output of the amplifier sets in motion the motor operating the hydraulic door opener. The door is thus held open for a sufficient length of time to allow the passage of the person for whom it was opened, and is then closed by a spring. It would be equally possible, of course, to leave this to be done by a second lamp and photoelectric cell; though the relays would be necessarily more complicated to allow for two-way travel.

The Radio-Crystal Clock

Electric clocks, operated from remote-controls, are quite familiar nowadays in most cities. They derive their time-keeping

accuracy from a regular correction of the signal impulses, ultimately obtained through observations of the heavenly bodies at astronomical observatories. The clock shown in Figures C and E, however, contains its own regulator in the form of a quartz crystal, which serves the purpose of the pendulum in an ordinary clock; yet with such precision that there is an error in its operation of less than one part in a million; in fact, a series of tests checked with astronomical observation signals indicate that the error is around one one-hundredth of a second a day, or four seconds a year.

As mounted complete, the electric clock (Fig. C) comprises a temperature-control unit in the cylinder underneath the bell jar, which contains at its heart the frequency-regulating crystal; in the shield can below is located the complete oscillator unit, which is shown opened in Fig. E. The oscillator's master frequency is 100,000 cycles. The clock itself is driven by a 1000-cycle synchronous motor, which is kept constant through two "submultiple" generating circuits, which step down the master frequency through its tenth and hundred harmonics. Similarly, 100- and 10-cycle frequencies are obtained with practically absolute precision.

Since, in precision work, it is necessary to have methods of checking up the functioning of the apparatus at all times, means have been devised of checking the timekeeping regularity of one clock against another, to be sure that they do not deviate. The accuracy of this comparison amounts to one instant in a hundred million, or around one-third of a second a year.

The Largest Radio Tube

While the large cylinder shown in Fig. D is strictly for radio purposes, it is not of the type that the set owner or the amateur will find use for. It is a 200-kilowatt transmitting tube, the largest yet produced, and designed especially for use in the new transmitter of station KDKA at Saxonburg, Pa.

Its size may be judged from the picture, at the left of which may be seen other tube models of all sizes.

This tube, "Model AW-200," when fully jacketed, is six feet high, eight inches in diameter, and weighs sixty pounds. As may be seen, it is double-ended. The principal problem encountered in its operation is that of cooling the grid; for this purpose, five tons of water are circulated through the tube in an hour.

Such a tube will take a sufficient amount of power to operate some eight thousand '50 tubes, the largest built into receiving sets, or a hundred and eighty thousand '27s. The 200-kilowatts of its rating is equivalent to some 260 horsepower.

An Outer-Grid Tube

In marked contrast to this giant among tubes, we have finally the smallest receiving tube—in girth at least—the new "Arcotron" or "stick-tube" which is being introduced into German commercial receivers. It is shown in Fig. F, in comparison with an ordinary small receiving tube, just below it. The Arcotron is very slender, containing only a filament and a plate inside the glass; while the grid is a thin coating of metal over the outside of the thin, narrow glass bulb.

In several respects this tube differs from any of the types now in general use, and we therefore append some information as to its character, together with one of the circuits in which it is commercially employed.

The idea of an external grid was suggested during the first days of vacuum-tube development; it occurred to Lee de Forest as early as 1906. It was followed up by more than one inventor, and then quietly dropped; since the models produced were quite lacking in efficiency, principally because of the space separating the elements. In the new tube, however, this difficulty is overcome. A cross-section (Fig. 1A) shows the closeness of filament, plate and grid. At the same time, the structure is not complicated. The tube base used has but three prongs (Fig. 1B); that in the center connecting with the plate, while the two outer terminals are for the A.C. filament, so that reversing the tube in the socket causes no difficulty. The grid makes a contact with the metal rim of the socket.

In its characteristics, the "Arcotron" offers a sharp contrast to previous tube models. It was designed exclusively for resistance-coupled amplification; there are two models, a gas-filled tube for the first position (detector) in a set, and a high-vacuum tube for the first audio stage.

Peculiar Voltage Effects

In an ordinary tube, when a negative voltage is placed on the grid, this drives back electrons upon the filament, and causes a space-charge which reduces the flow of plate current. In the "Arcotron," the grid is separated from the contents of the tube by highly-insulating glass dielectric. The result is that a positive voltage on the outer

(Continued on page 307)

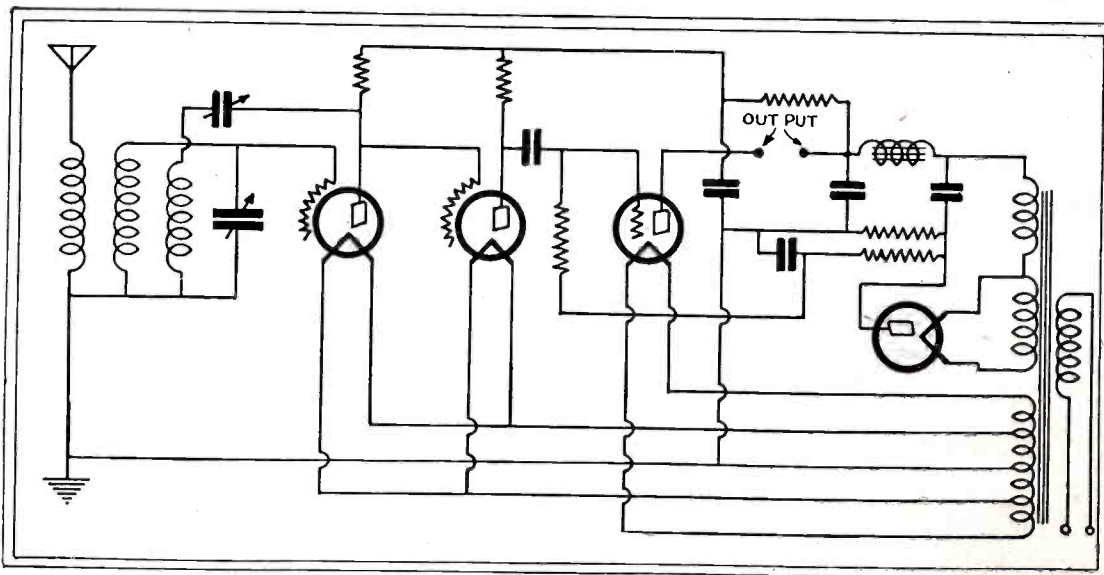
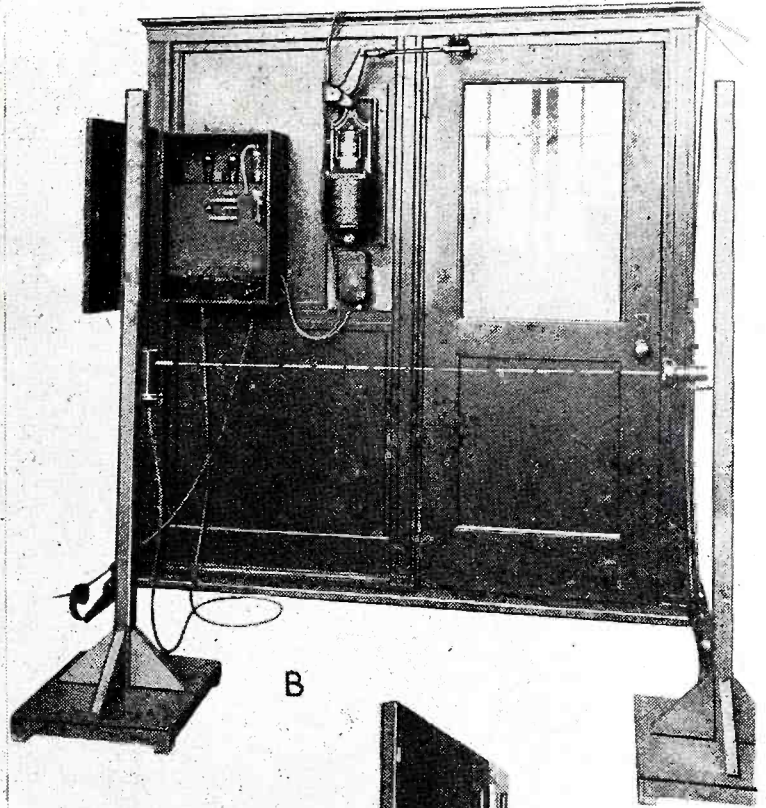
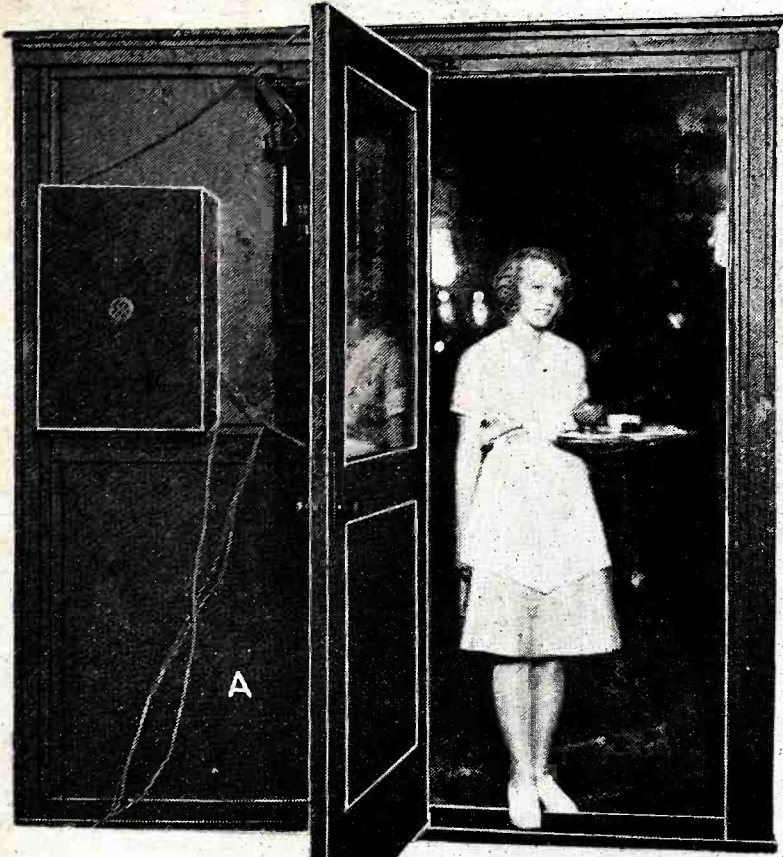

Fig. 3

The circuit of the first receiver to employ the new "Arcotron" tubes, in which the grid is outside the glass of the tube; the first tube is a gas-filled detector, the second a high-vacuum amplifier; the third a normal three-element power tube. The simplicity of this electric set is evident. It is a German commercial model.



The mystery of the open door in the cover picture, and as shown also in Fig. A, above, is better explained in Fig. B, at the upper right. Here we see the vacuum tube amplifier, in the box on the panel, and the hydraulic door opener which it operates through a small motor. The signal for the operation of the relay is given by the photoelectric cell, in the cylindrical can on the post at the left, when the light is cut off.
(Courtesy of General Electric Company.)

The apparatus in Fig. C (center) is an electric clock regulated by a quartz crystal, kept at a constant temperature under the glass bell-jar. It is driven by the vacuum-tube oscillators in the box below, which are shown separately in Fig. E (lower left). Each division on the tuning knob alters the clock's rate about 32 seconds a year.
(Courtesy of Bell Telephone Laboratories.)

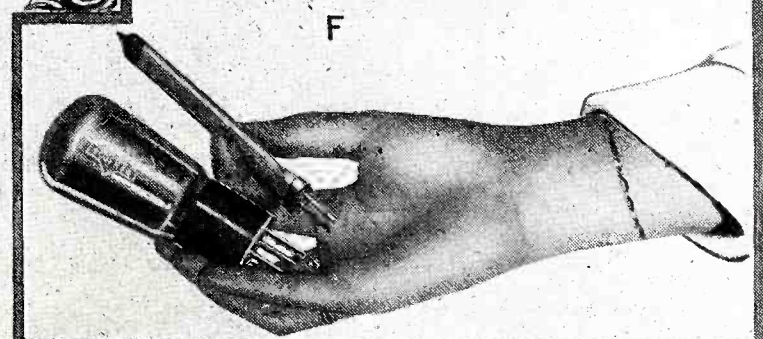
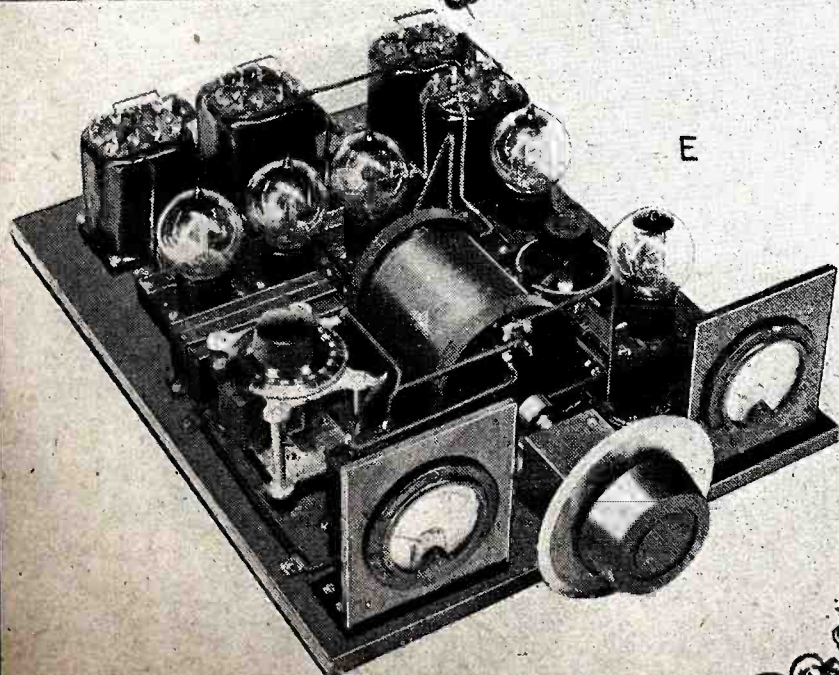
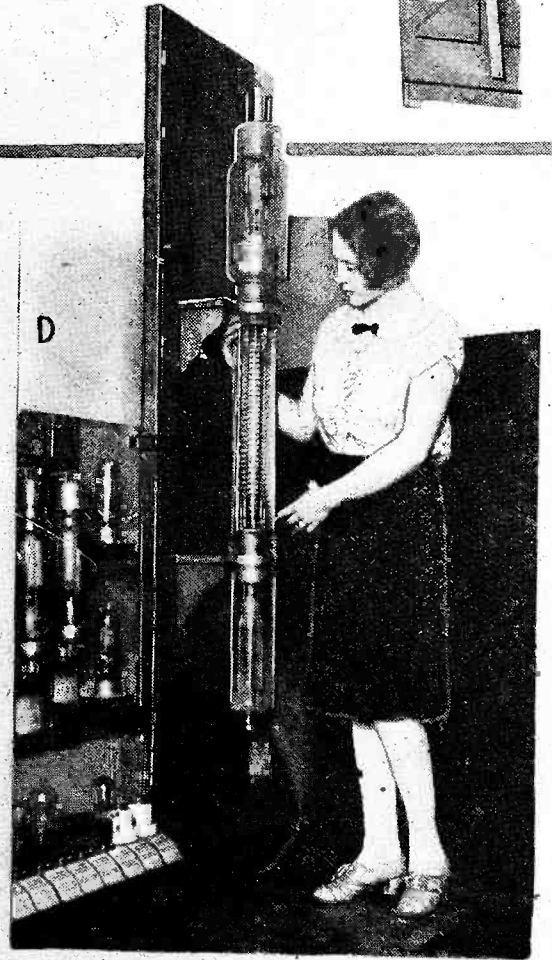
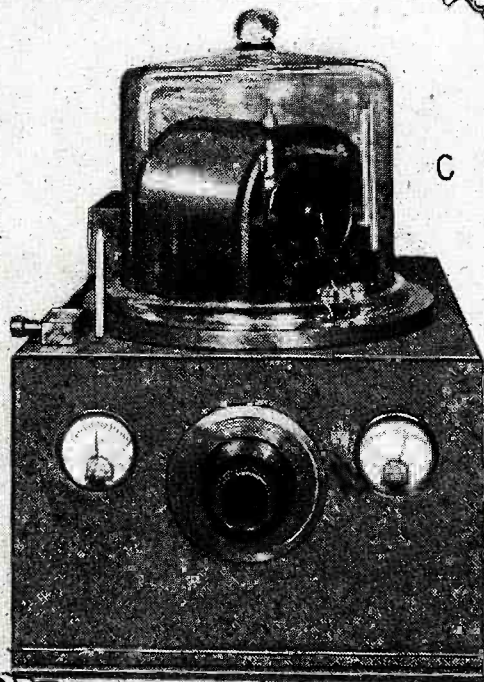

In Fig. D (center right) the world's most powerful radio tube, capable of handling 200 kilowatts of power, which has been designed for the radio-frequency amplification needs of the new transmitter of KDKA at Saxonburg, Pa.
(Courtesy of Westinghouse Electric & Mfg. Co.)
The tiny object uppermost in Fig. F (lower right), the newest thing in receiving tubes, is a German invention.
(Courtesy of the Telefunken Company.)

SHORT WAVE CRAFT

The "Radiola 28" at 80 Meters

By RICHARD CARMAN

THE very efficient short-wave receiver illustrated in Figs. A and B, was constructed by utilizing a catacomb taken from an old "Radiola 28." The following description covers the details of coils only for the 3500-3550-kc. (85-meter) amateur phone band. Coils for other bands are in the process of development and, when completed, will be described in a forthcoming issue of RADIO-CRAFT.

When using the set for phone a part of the circuit (known as the "beat oscillator") is not used; it is required only when C.W. signals are to be received. The coils employed in this section are the oscillator coils from a Radiola 25, or the "semi-portable" (or "Model AR-812") superhet. There are four coils in this group; hook up the entire four in series and connect as shown at L3 in Fig. 1.

The Eighty-Meter Coils

Very carefully remove the top cover of the catacomb (first being positive you have secured a perfect catacomb), when you will find that you may utilize some of the connecting posts just underneath the "cat." cover, rather than solder leads to the wire "whiskers" coming from the catacomb. In doing this, be extremely careful not to disturb the leads in their numerical rotation, as stamped on the strip just underneath the edge of the catacomb where the 19 wire leads or "whiskers" protrude. Also, be sure not to disturb the leads coming from the heart of the "cat." to these posts.

A shield can must be secured, sufficiently large to contain the oscillator coil and its variable condenser. The antenna coil and its tuning condenser may be located outside the shield can, as shown in Fig. B. The coil illustrated in the photograph has been wound on large bakelite tubing; but it may be more easily and better made by winding on a 4-prong UX-tube base.

In this case, the pickup coil L1 has a primary of 9 turns of No. 28 silk covered wire (connecting to two of the UX prongs) and a secondary of 30 turns, wound next to the other winding, on the same UX base, connecting to the remaining prongs. The oscillator coil also is wound on a 4-prong UX tube base, and has 36 turns, exactly center-tapped. The three connections are soldered to three of the UX prongs.

You will notice that there is on the number 11 lead in the oscillator circuit a resistance R5 connecting to the ground (Fig. 1). Experiment with the value of this resistor, between 50,000 ohms and 100,000 ohms, until best results are obtained.

The part of Fig. 1 enclosed in dotted lines is the "beat oscillator." It is put in operation for C.W. by the S.P.S.T. switch SW1. When receiving phone signals leave this switch open and you may remove the tube in this part of the circuit. This tube is marked "Beat Osc." in Fig. 1.

The last audio stage should use a type '20 tube. Special care should be used to select a specially good '99 for the first socket.

Characteristics of the Super

If the set does not operate when you complete it and have carefully checked everything to see that there are no mistakes, or if it does operate and suddenly quits, this is caused by the oscillator's "blocking" but can be readily corrected by disconnecting the positive 90-volt lead momentarily.

Due to the upper and lower beat frequencies being close together, you will have "two-spot" tuning. One of these points will be considerably sharper and louder than the other. (In all probability we will be able to clear up this difficulty and present the solution to you in this magazine in the near future.) This effect, however, is not a decided disadvantage, even though undesirable. The excellent results obtained in all-around operation far more than make up for this slight deficiency.

A voltmeter will be very effective to keep the filament potential at exactly 3.3 volts, as per manufacturer's specifications; insuring the longest life and best operation. If the entire set is mounted in a metal cabinet, it will be possible (or nearly so) to operate the receiver "break in" (that is, while the transmitter is in operation).

If a closed-circuit jack is installed in series with the plate circuit of the oscillator, and phones plugged into this jack, the set will function as a very good monitor to listen to and check the performance of your transmitter.

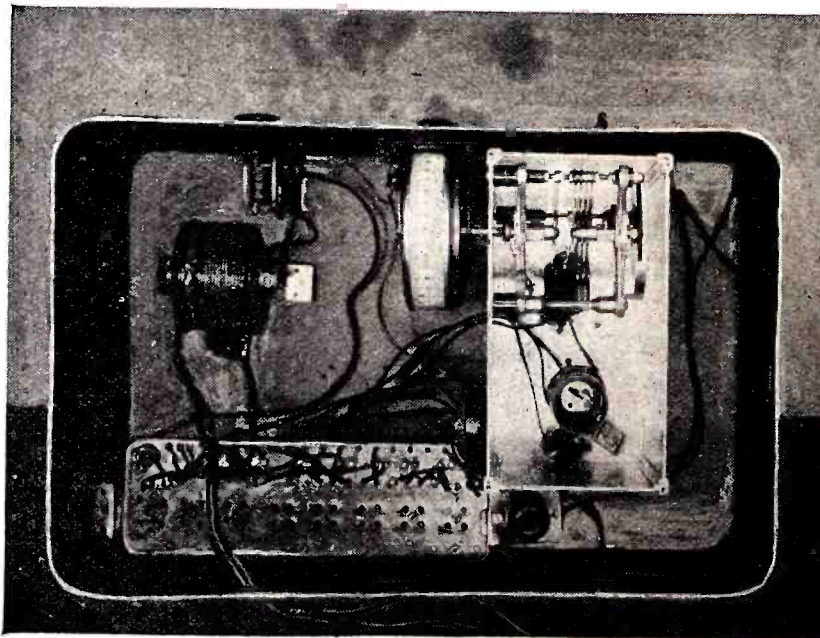

Fig. B

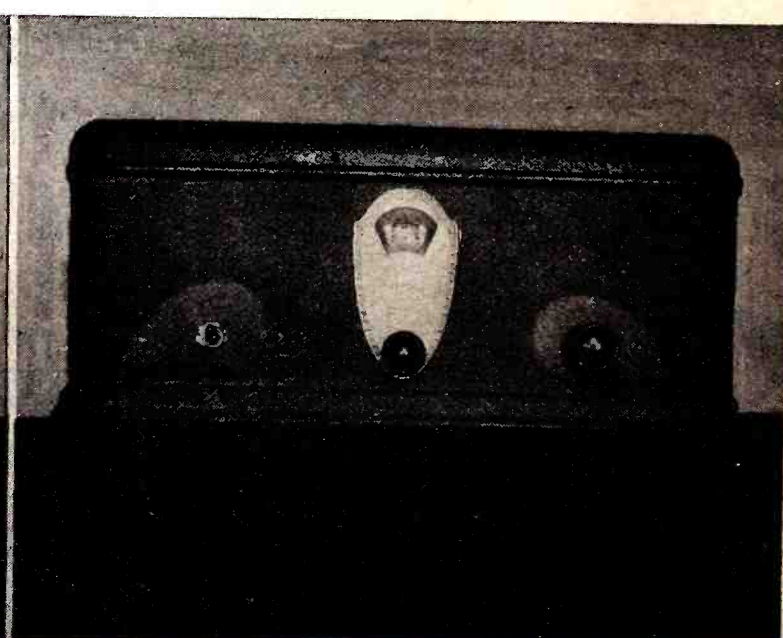

Fig. A

The short-wave receiver designed by Mr. Carman, which employs a "Radiola 28" catacomb as its intermediate and audio stages, is very conveniently housed in the standard metal cabinet shown in Fig. A, at the right. The layout of parts, which is roomy, may be easily followed in the interior view at the left, with the aid of Fig. 1. The tube sockets are clearly visible at the top of the catacomb, which is placed at the rear of the cabinet. The third socket from the left is needed only during the reception of code, when its tube is employed as a local oscillator.

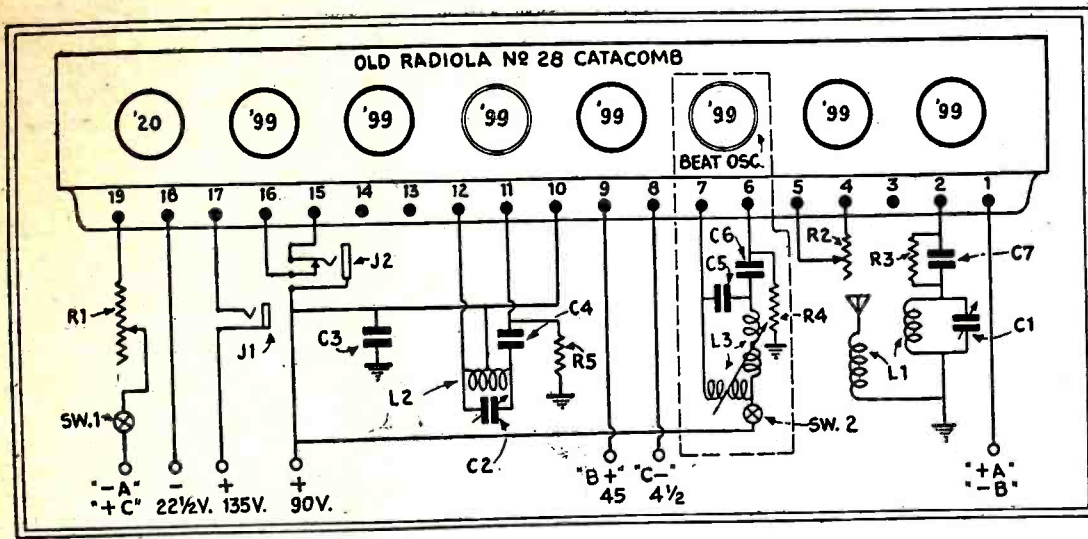

Fig. 1

The "Radiola 28" converted to the amplifier of a short-wave super; the beat-oscillator '99 tube is used only for code reception and may be removed from its socket while listening to phones. The circuit shown is designed especially for amateur work.

Experimenting with the antenna will be necessary in different localities to obtain the highest degree of efficiency. Different aerials and ground combinations are a

seven-foot and ordinary water-pipe ground; ground with no aerial; various lengths of aerial and no ground; a rain-leader pipe connected to the antenna post. You can

determine which will best suit your own conditions. The set can be operated by an "A" and "B" eliminator; but the writer has obtained best results by using batteries throughout.

As soon as further details in the adaptation of the set to other short-wave work have been satisfactorily determined by test, the desired constants will be given the readers of RADIO-CRAFT.

List of Parts
(See Fig. 1)

- Two 25-mmf. variable condensers (C1, C2);
- Two .01-mf. fixed condensers (C3, C5);
- One .001-mf. fixed condenser (C6);
- Two .0005-mf. fixed condensers (C4, C7);
- One 6-ohm rheostat (R1);
- One 60-ohm rheostat (R2);
- One 10-meg. grid leak (R3);
- Two 50,000- to 100,000-ohm resistors (experiment for best value), (R4, R5);
- One single-circuit jack (J1);
- One closed-circuit jack (J2);
- One metal cabinet, or cabinet with panel;
- One binding-post strip, 9 terminals;
- One "Radiola 28" superhet catacomb.

The Why and How of the Short-Wave Super

By L. W. HATRY

LAST month the writer discussed in this department of RADIO-CRAFT the subject of oscillators (frequency-changers), audio amplifiers, and a few other considerations that enter into the design of a short-wave superheterodyne receiver which will really work, and realize the gain that should be theoretically possible.

This month he will dig into his bag of tricks, drag out the "intermediate-frequency amplifier," and make it talk pretty to you.

What is the best intermediate frequency for short-wave reception, and why? What is the most satisfactory method of obtaining selectivity in the I.F. amplifier, and why? Is it possible to make a good short-wave superhet, without tuned-R.F. (signal-frequency amplification ahead of the first detector, and how? Is it practicable to use the regenerative amplification possibilities of the second detector?

To these questions, and a number of others raised here, the answers which have been found in the laboratories of the writer are given in this article.

Before going further, the attention of the technician who is already experienced in superheterodyne design should be directed to the fact that the considerations for successful short-wave work are entirely different from those of operation at the broadcast wavelengths of 200 to 550 meters. The previous installment of this article in the October issue of RADIO-CRAFT (and articles by the same writer in the pages of SHORT WAVE CRAFT) should have made this clear.

For Amplification and Selectivity

Amplification (or sensitivity) and selectivity are the two counts on which to judge any intermediate-frequency amplifier.

A correct intermediate frequency is the most important single value in the design of a superheterodyne receiver whose first detector is not preceded by one or more stages of tuned R.F. amplification, whether or not the I.F. amplifier is shielded. If this sounds

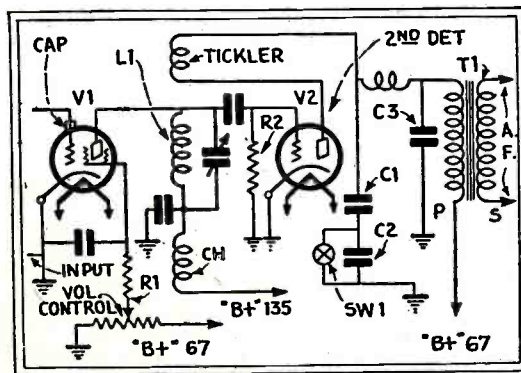

Fig. 1

A regenerative second detector feeding back into a tuned I.F. amplifier causes interlocking and noise.

as though shielding might serve the same purpose when other limitations prevent the selection of the correct I.F. (for example, when it is desired to utilize a set of available I.F. transformers) I hasten to correct the impression. Exceptionally good shielding may help toward the result obtained by correct I.F.; but the most perfect shielding cannot do as much as the use of the correct I.F. will accomplish without shielding.

The effective amplification is limited by the choice of tubes. If three-electrode (type

'99, '01A, '40, '26, or '27 tubes) must be used, our I.F. cannot be above 400 kc., unless shielding is employed to prevent loss of signal strength and circuit oscillation. In fact, an unshielded I.F. amplifier of good design would not go above 100 kc. As we advance toward 400 or 500 kc. shielding must be used; and toward 1,500 kc. we must use some method of preventing oscillation (such as neutralization, or grid suppressors) in addition to shielding. If the four-element ("tetrode") '22, '32, or '24s are used, we can go to 500 kc. without shielding, and to 3,000 and more with its aid. But even the tetrode is an effective amplifier only below 1,500 kc.; from about 1,500 up it drops off; until at about 20,000 kc. it practically ceases to amplify. From the standpoint of sensitivity, therefore, the intermediate frequency chosen for a short-wave superheterodyne receiver must be between 1,500 and 30 kc.

Effective selectivity, in the standard superheterodyne, without tuned signal-frequency amplification, is determined by the single tuned circuit of the first detector and the intermediate frequency. Such a receiver, using a loop, has the directional effect of the loop as an additional help to

(Continued on page 308)

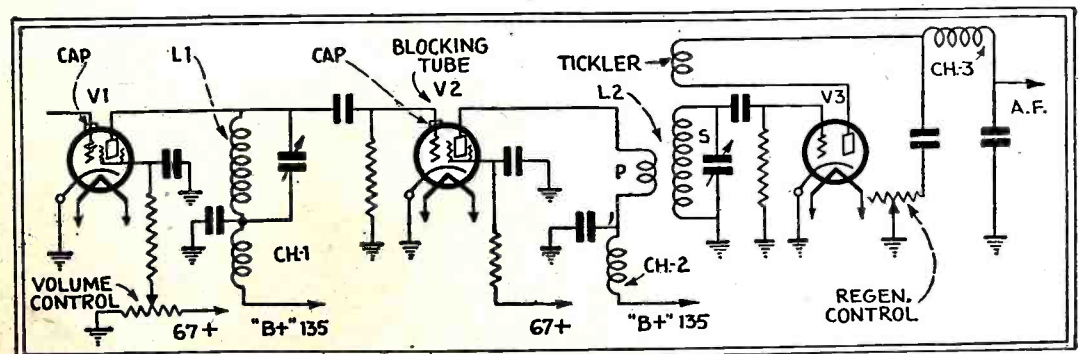

Fig. 2

The blocking tube V2 in this circuit serves the purpose for which an untuned R.F. stage is often put ahead of an ordinary regenerative detector, either on the broadcast band or short waves. While it does not give its full amplification, it affords some, and prevents trouble.

Short-Wave Stations of the World

All Schedules Eastern Standard Time: Add 5 Hours for Greenwich Mean Time.

Table of radio stations with columns for frequency (Kilo-Meters cycles), call letters, and location. Includes stations like W2XBC, W8X1, W2XCU, etc.

Table of radio stations with columns for frequency (Kilo-Meters cycles), call letters, and location. Includes stations like OBE, W2X0, W2XAF, etc.

(NOTE: This list is compiled from many sources, all of which are not in agreement, and which show greater or less discrepancies; in view of the fact that most schedules and many wavelengths are still in an experimental stage; that daylight time introduces confusion and that wavelengths are calculated differently in many schedules. In addition to this, one experimental station may operate on any of several wavelengths which are assigned to a group of stations in common. We shall be glad to receive later and more accurate information from broadcasters and other transmitting organizations, and from listeners who have authentic information as to calls, exact wavelengths and schedules. We cannot undertake to answer readers who inquire as to the identity of unknown stations heard, as that is a matter of guesswork; in addition to this, the harmonics of many local long-wave stations can be heard in a short-wave receiver.—EDITOR.)

Table of radio stations with columns for frequency (Kilo-Meters cycles), call letters, and location. Includes stations like UOR2, GSSW, CJRX, etc.

Table of radio stations with columns for frequency (Meters), call letters, and location. Includes stations like WIXAZ, W2XAF, OZY, etc.

(Continued on page 316)

The Car Battery for Automotive Radio

By SOLOMON PERLMAN

WITH the coming of automotive radio, new opportunities and new problems are opened to the Service Man; as by the use of the automobile's storage battery to light the filaments of a car's radio set. In receivers incorporating '24 and '27 type tubes, series-parallel filament circuits are required; and, in many cases, the voltage drop across the heaters of these tubes supplies grid bias. For this reason, it is necessary to exercise proper care in determining the polarity of the filament leads.

Usually, the negative side of the battery is grounded to the car frame; and there is then no additional installation problem; since the metal shielding of the set is the negative filament connection. However, when the car battery is grounded at its positive terminal, it becomes necessary to reverse its terminal connections, to bring it into proper relation with the radio receiver; and also to effect certain changes

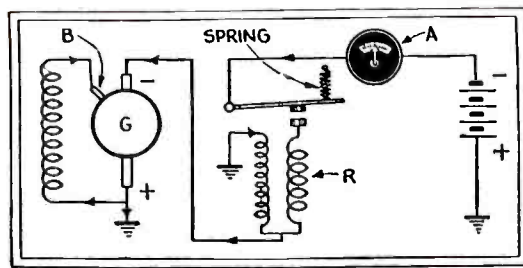

Fig. 1
Connections of a car's generator and battery.

in the charging system. To understand these, the following explanation should be considered.

Automotive Electrical Systems

The charging apparatus comprises four elements: the storage battery, the generator, the reverse-current relay, and the ammeter. The manner of their connections is shown in Fig. 1.

The generator G is a direct-current machine, which incorporates a third brush (B) to control the current output; so that this will remain fairly constant over a wide range of speeds.

The reverse-current relay R has two windings: one of many turns of few wire, which is the coil operating the relay; and the other of few turns of heavy wire, which is in series with the contacts. The first operates the relay when the output potential of the generator reaches about 12 to 14 volts; while the other is so wound that it will partially demagnetize the relay when the generator is charging the battery. When the voltage of the storage battery approaches that of the generator, and the magnetic field is sufficiently weakened, the spring on the armature opens the contacts. This prevents the storage battery from discharging back into the generator.

For automotive use the ammeter A must
(Continued on page 309)

Mounting The Loud Speaker for Automotive Radio

By YATES M. HOAG

THE location of the loud speaker in a radio-equipped car is fixed, generally, by the model and type of the automobile. In the larger cars, or coupes of practically any description, the speaker may go under the cowl, over the windshield, or in any other convenient location. But in the popular small sedans, touring cars, etc., there is apparently no good place for a speaker, and particularly for one of the regular magnetic cone type that will give good reproduction.

In my own car, a small coach, I carried a little 8-inch horn secured over the mirror; but after a short time it became apparent that the quality of reproduction was unsatisfactory. An RCA "Model 100A" speaker gave excellent quality, for an automotive installation; but there was seemingly no place to put it, out of the way.

I then conceived the idea of mounting it in the floor. A suitable opening was then cut in the rear floor boards, behind the right front seat; it might have been made on the left side, but not in the center, because of the driving shaft. This was done with a keyhole saw, without removing the boards. The speaker chassis was then mounted on the under side, by the use of stove bolts, with the cone facing upward through the hole. One grille cloth frame was then mounted, flange down, and a piece of heavy screen, nearly as large as the cloth, was laid over it; then the other frame, with the cloth removed, was placed on top, flange up. The whole assembly, as shown here, may be secured with the same stove bolts.

For the sake of appearances, it is desirable to cut the "ears" from the frames before mounting them. The first frame, with

its cloth, and the screen protect the speaker against large particles of dirt, and the screen is heavy enough to be stepped on without damage.

Finally a square box, of the proper size to fit over the speaker, was constructed and fitted to protect it from mud, dust and water. The completed arrangement, as at the left, is compact and convenient. The box was painted with several coats of black, inside and out, to weatherproof it, and a gasket of weather-strip was cut to make a tight fit to the floor, against which it was held by angle irons and wood-screws. A metal cover would probably have served,

if one had been at hand.

Finally, of course, a hole of suitable size was cut through the floor covering, above the speaker, to finish the job.

This method of mounting the car reproducer not only gets the instrument out of the way, but seems to assure better sound distribution in the interior of the body.

(It is considered that proper baffling requires an opening behind the reproducer diaphragm, as well as in front of it, to prevent resonant effects and back pressure on the diaphragm. However, the arrangement described may give good results under the conditions described.—Editor.)

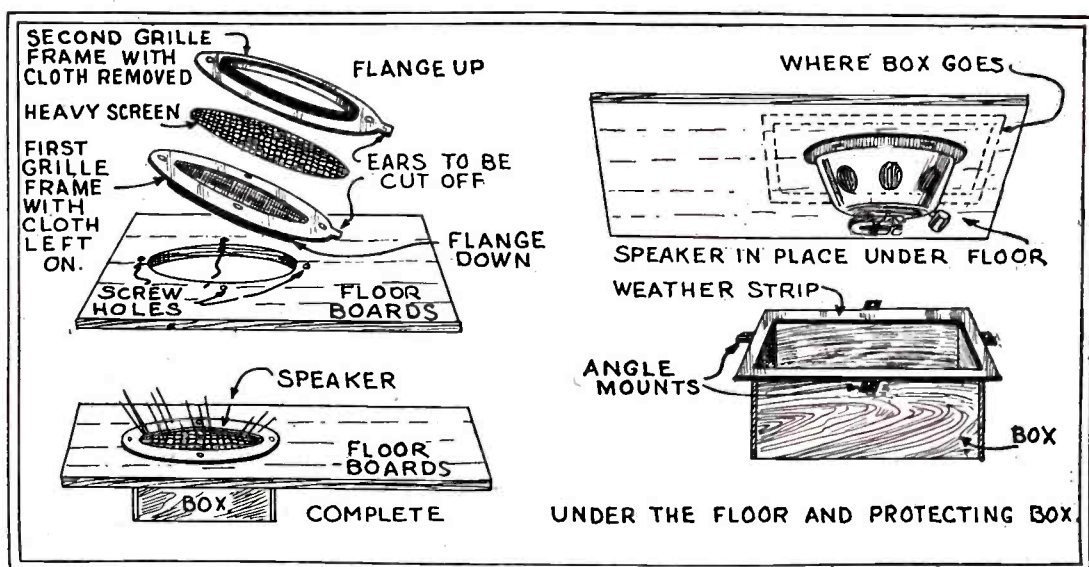

The arrangement shown was used to fit a magnetic cone speaker under the floor of a car, giving good sound distribution within. At the upper left, the units of the assembly, which is shown completed below. The speaker itself was attached beneath the car with stove bolts, as shown at the upper right; and protected from below by the square box whose details are shown at the lower right.

A "Roll Your Own" Superheterodyne

This set was built by a custom builder on a special order for a customer who wanted distance. It is simple and readily constructed of standard parts; the single I.F. stage introduces little difficulty.

By W. E. SMITH

IN the writer's experience, the greatest number of radio set builders began building sets by substituting parts in circuits they read about; but, after the initial interest has subsided, they buy and assemble complete kits. Yet the constructor can eliminate many of the costly parts by "rolling his own."

Personally, I believe that the radio-wise constructor does not care for a mere review of kits, without full constructional data; and I should like to see in each issue of RADIO-CRAFT the description of a complete receiver for the experimenter. I therefore present here an account of a receiver which I designed myself, and built for a friend, under circumstances which may interest other custom builders.

A Large Order

While visiting in my shop the customer commented on a set I built for him in 1927, a five-tube regenerative hookup with a '22 R.F. stage; and commented that the ordinary commercial set will now bring in as much DX as this special model. What, he asked, could I offer that would be a little bit ahead of the neighbor's. I had not anticipated an order; but he finally told me, that if I could build a better set, to do so and deliver it.

After he had gone, I made a mad dash for all the catalogs and magazines. I had a feeling that I was up against it but, after examining the various circuits, I decided on a superheterodyne. High-degree selectivity is obviously essential, and a large output with fine tonal quality for a dynamic reproducer. I finally decided on the well-known Ultradyne system with two stages

of R.F. amplification ahead of the modulator, a screen-grid ('22 type) intermediate-frequency amplification stage, a regenerative second detector, and two stages of audio. The circuit is shown in Fig. 1.

This combination was completed and in the customer's home within four days and, after thorough trials, was finally installed

WLW, WTMJ, WOC, WHA, KSD, KTNT and a few others come in regularly in daylight in the heart of Chicago without interference or cross talk. An interesting feature, which eliminates the old "fly in the ointment" of supers, is that the repeaters can be prevented from interfering, by tuning the I.F. couplers.

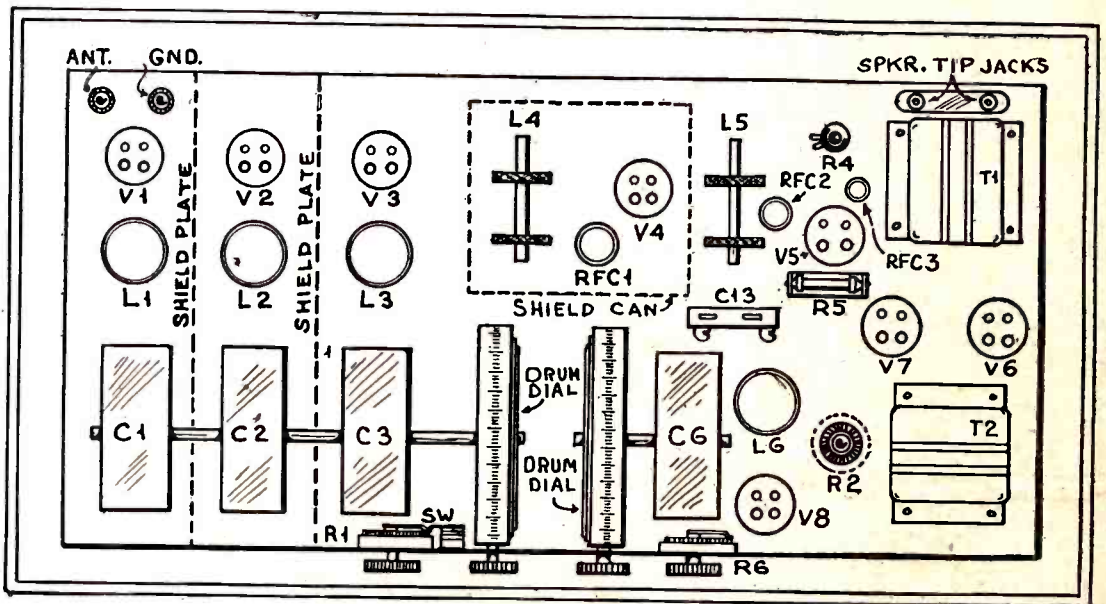

Fig. 2

The layout adopted by the author; the R.F. stages are separated by simple plates, but complete shielding would be better. This set, with smaller tuning condensers, might be used to cover short-wave as well as the regular band.

in a suitable cabinet. It is worthy of first-class components and good housing; it will bring in plenty of "DX." Stations a thousand miles distant are picked up in the middle of the day with loud-speaker volume.

Construction Hints

In laying out a set, the best method is to master the schematic diagram, then start in with the first R.F. stage, and mount each (Continued on page 311)

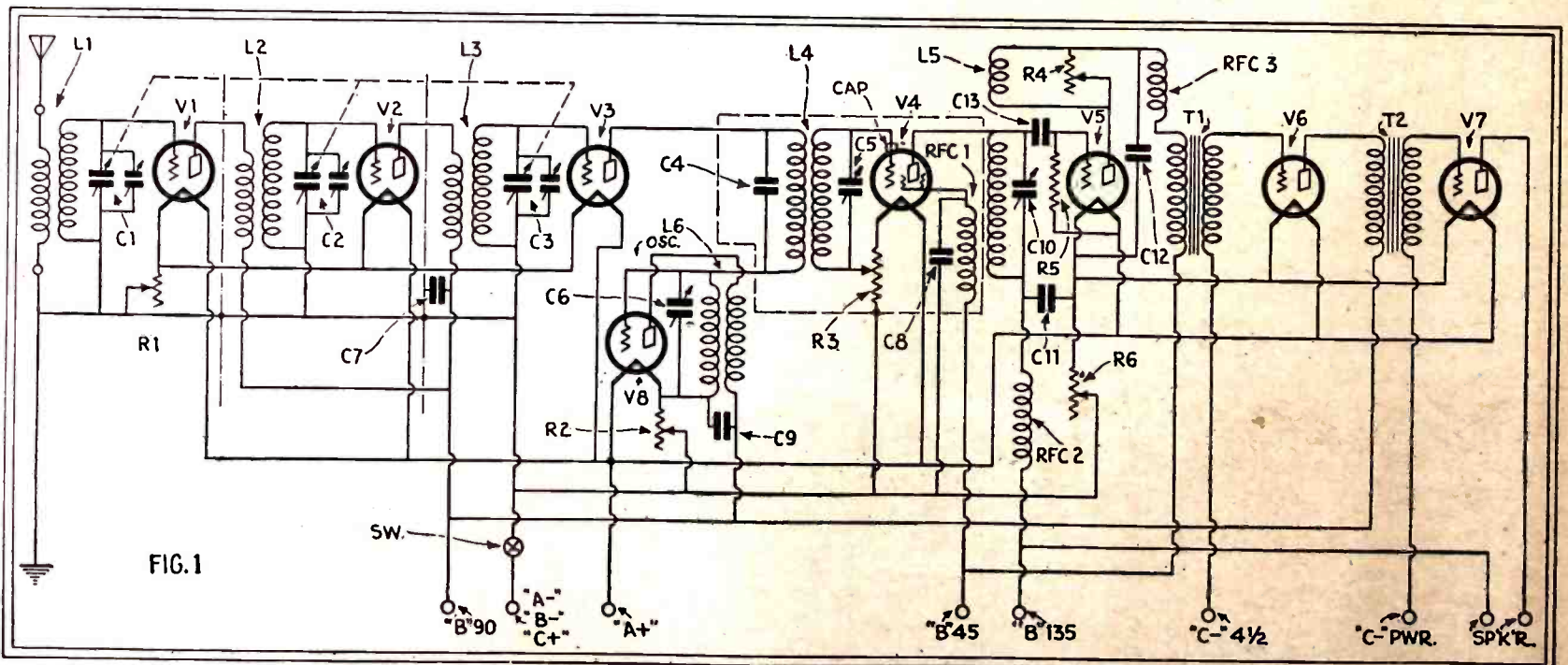

Fig. 1

The circuit adopted by Mr. Smith. Three tuned circuits ahead of the frequency-changer give high selectivity, and reduce the problems of I.F. amplification; for which a single screen-grid tube is used. This, a battery model, might be very economically adapted to the new two-volt tubes. The choice of the resistor R2 is important.

Automatic Volume-Control Design

The principle of this popular improvement, found in the latest sets, and methods for applying it to older models

By C. H. W. NASON

DURING the past season, several receivers incorporating "automatic volume control" have appeared and, at the trade show in Atlantic City, an increased number of manufacturers were found to have incorporated this arrangement in the models which will be offered during the coming season.

The arguments for the system are many and good; while those who are opposed to its use seem to have no excuse but a feeble inclination against the acceptance of anything startlingly new. It is necessary for the Service Man to understand the principles of this, and all similar innovations in receiver design, regardless of his personal opinion of their utility. For this reason, a brief explanation of the operation of various automatic volume-control systems is presented here.

The function of the automatic control circuit is to maintain a constant level of output at the loud speaker, regardless of the strength of signal available at the antenna. By means of a manual adjustment, this mean level may be established at any desired point. In the case of strong local stations, the automatic control prevents the terrific crashes of sound which are caused when tuning from one to the other, on the ordinary receiver. In the case of weaker distant signals, the device operates to minimize the effects of "fading"—provided the manual control is set so that the desired volume level corresponds to that obtained from the smallest signal strength available while the fading is in progress. As stated in past issues of RADIO-CRAFT, automatic volume control seems to be the solution to the troublesome problem of signal fading which is fundamental in automotive radio installations because of ever-varying reception conditions. Stationary installations are not subject to this handicap, common to mobile installations.

Manual Control Methods

You are of course familiar with the two generally employed systems of control, whereby the control-grid bias of the R.F. stages is made variable or (in some screen-grid circuits) the potential applied to the screen-grids is varied. In Fig. 1, both these systems are shown in schematic; please note that at A the biasing resistance comprises both a fixed and a variable section.

When increasing our volume, by decreasing the bias on the R.F. grids, there is a

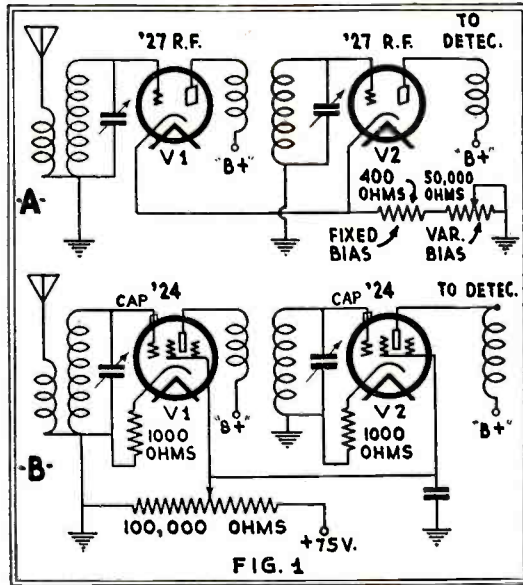

Above, the standard methods of volume control in electric sets; the bias on the grids (A) or screen-grids (B) is regulated by hand.

minimum voltage below which we must not go if the tubes are not to draw grid current. This value is that set down in the tables furnished by the tube manufacturer. If grid current is drawn, a spurious impedance appears across the transformer secondaries and all evidences of selectivity are lost.

These same two systems are applicable in the case of automatic control and the circuits are similar, except for the fact that the volume is controlled by means of the changing plate current in an additional tube connected as a vacuum-tube voltmeter.

In Fig. 2 we have the schematic circuit of an automatically-controlled system operating on the control grid bias of the R.F. stages which, in this diagram, are represented by a single tube V1. The different voltages, as they are taken off the voltage divider, have been indicated, to assist you in visualizing the process of operation. The bias on the volume-control tube V3 is made manually variable, in order to control the amount of plate current drawn with a given value of input signal.

The input to this tube is taken from the grid of the detector tube V2. When no plate current is drawn by the volume-control tube, there is no voltage drop through the resistance "R," and the effective bias of the R.F. tubes is of the normal value, as indicated in the figure.

When a signal is impressed on the grid of the controlling tube, current is drawn through the resistance "R"; both the current and the voltage across the resistance are controllable by the variable bias adjustment R1. It may be readily seen that the voltage drop across the resistance R is added to the grid bias already applied to the R.F. tubes, and the effective voltage on the grids is increased with a corresponding falling off in the gain through the R.F. stages.

If the circuit is properly proportioned, all impressed signals will give a similar value of output at the speaker terminals—a value which may be adjusted at will by setting the bias on the control-tube grid at the desired point.

Use of Resonance Meter

Because of this levelling-off effect it is difficult to ascertain the exact point at which resonance occurs; and it therefore becomes highly desirable to include a meter MA, to give a visual indication of resonance in tuning. When this point is reached, the current in the plate circuit of the control tube is at a maximum; an 0-1-scale milliammeter may be employed.

The visual indicator may also be placed in the plate circuit of one of the R.F. stages; in this case resonance will be indicated by a minimum value of plate current. The meter used will then depend upon the tubes employed in the R.F. stages. For a '27 the meter should have a maximum reading of 10 mils and for a '24, 5 mils.

Constructing an Automatic Control

By utilizing the principles herein outlined, it should not be difficult to evolve a control unit for application to receivers already in service. The writer has constructed two such units: one for screen-grid receivers and the other for earlier models.

The first, shown in Fig. 3, may readily be adapted to become an integral part of receivers constructed later; since the desired voltages may be readily obtained by re-designing the power-supply circuit, rather than by means of batteries as shown here. The filament supply may be obtained from the set, or from a separate 2.5-volt transformer included in an external unit. It is essential that the switch shown in the diagram be included, in order to avoid running

(Continued on page 313)

In the first diagram (Fig. 2) the automatic volume control is schematically illustrated to show the division of voltages on the control-tube VC and the R.F. stages represented by V1. Next (Fig. 3) the constants for an automatic control for a screen-grid electric set. The circuit of Fig. 4 controls externally the loud-speaker volume of a battery set; and that of Fig. 5 may be connected to an '01A detector to govern its input.

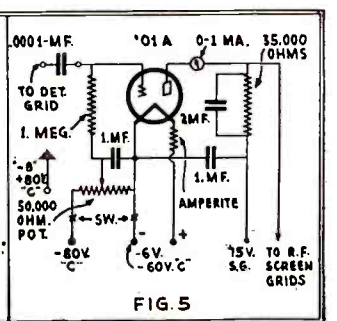
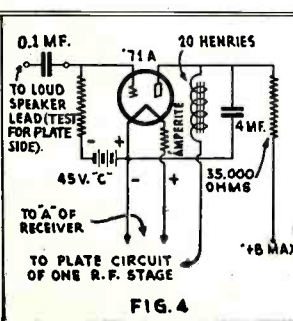
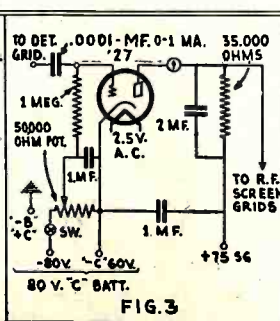
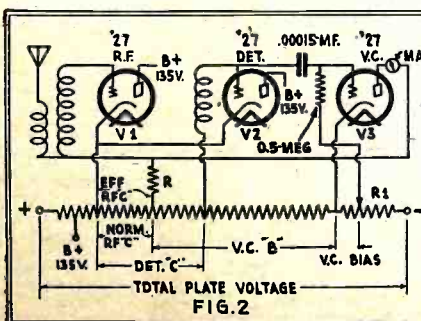

The Screen-Grid "Better Booster"

A little unit which will increase both the range and the selectivity of a standard broadcast receiver of the battery-operated type

By E. F. HENNING

THIS tuning unit, designed for use ahead of a standard broadcast receiver, is primarily intended to improve the performance of a five- or six-tube commercial set, which does not give the selectivity, or perhaps the volume, which the owner could wish. It will be found serviceable also, however, in connection with a selective set which fails to give the desired distance ("DX").

It was designed as the outcome of experiments with wavetraps after the use of the more usual arrangement of a tuned stage of screen-grid R.F. amplification, alone, failed to give the expected selectivity. The combination of booster and wavetraps, here described, obtains this and adds considerable volume to the output of a broadcast receiver; and it is so designed that it does not radiate through the antenna.

Receiving Range Widened

The unit was first applied to a "Model 35" Atwater Kent, with the result of separating KTHS from WMC; though there was then but 20 kilocycles between their channels, and the former is a 10-kilowatt station but 35 miles away, while the other has but 500 watts and the distance is more than four times as great. Then, too, KFI was separated completely from WSM, on the adjoining 10-ke. channel, which is four times as near. Moreover, with the booster on a favorable night a dozen stations on the Pacific coast could be brought in, ranging from the 100-watt KGER up; while without it, KFI and KNX alone could be heard.

In daylight, the advantage is perhaps more striking. The writer, in Little Rock, Ark., with the same set and the unit ahead of it, has had noontime reception of WLW, WGN, WMAQ, WSM, WDAF, KFEQ, KSD, WMC, WREC, KTHS, KUOA, WBAP, KRLD, KWKH, KMOX, WOW, KVOO, KTNT, WHAS, WSB and, of course, three locals. Without the booster, he could get

nothing beyond a hundred and fifty miles at this hour.

For this reason, the use of a booster unit of this type should appeal to anyone who is interested in improving both local and distant reception. It is especially intended for use on single-dial receivers; while it may be used with equal effectiveness on the three-dial set, the increased number of controls would present added difficulty of operation.

Design of the Unit

A glance at the diagram (Fig. 1) will show that we have a screen-grid R.F. amplifying tube V1 which feeds its output to the first R.F. amplifier of the broadcast receiver through the tuned circuit L3-C2; thereby making it possible to cut out interfering signals quite sharply. The switches SW2 and SW3 give the option of working either directly from the aerial to the receiver, through the wavetraps, through the screen-grid tube and wavetraps combined, or with the screen-grid amplifier alone, as conditions dictate to the operator.

The screen-grid amplifier and the wavetraps, generally, should be shielded from the receiver and from each other. However, the first model built by the writer has given very good results without shielding. Local conditions and the amount of interference present have a good deal to do with this.

The parts should cost but a few dollars; the average experimenter will have most of them at hand in his junk box. Here is the list of those used by the writer in his first assembly.

List of Components

Two Pilot .00035-mf. tuning condensers, straight-line-frequency type, and two Pilot "Art Vernier" dials (C1, C2);
Two Dubilier fixed condensers—one .001-mf. (C3) and one .006-mf. (C4);
Two Carter fixed resistors—one 10-ohm (R1) and one 8-ohm (R2);

ANOTHER OPPORTUNITY FOR SALES

THE letters of many Service Men and constructors indicate that there is still a demand for distant reception on the part of set owners, which offers an opportunity to be capitalized; especially as the fall and winter seasons of better reception are approaching.

In response to the general demand for receivers which are practically automatic in their tuning, commercial activity has been devoted to the production of apparatus which simply turns on and off, and which is satisfactory to the great number who wish merely local or chain program reception with loud volume.

There are many thousands of enthusiasts who are still willing to sit up and tune for distant stations, and take pride in their log. For these enthusiasts, the "Better Booster" described by Mr. Henning will make it possible to enjoy their hobby at very low additional cost, and with no alterations on their regular broadcast receiver. It therefore presents a money-making hint which many of our readers will not be slow to turn to advantage.

One "Twin Coupler" R.F. coil for .00035-mf. condenser (L1);
One National 85-millihenry R.F. choke coil (L2);
One home-made coil—see text (L3);
One Buffalo UX socket, and one Peewee clip, for V1;
Three Walbert snap switches—two S.P.S.T. (SW1, SW2) and one S.P.D.T. (SW3);
One DeJur 8-post terminal strip (7 used);
One panel, 7 x 12 inches, and baseboard, 7 x 11 inches.

Coil Data

L3 was wound on a 3-inch length of 3-inch tubing, with 70 turns of No. 28 D.C.C. wire, leaving leads about five inches long.

L1 was used with about 10 turns removed from the secondary (and the primary unused); but it may be wound, if so desired, on a 1-inch tube of the same length, with 125 turns of No. 28 D.C.C. wire, leaving leads of suitable length. Coils L1 and L3 may be given a coating of celluloid cement, to hold the windings in place.

If L2 is to be made by the constructor, since it is intended for use as an R.F. choke, it should be wound haphazard. The core is half an inch in diameter, and 5/16-inch thick. The flange sides are 2½ inches in diameter, and made of bakelite or hard rubber. The choke should have 1500 turns of No. 36 wire; the type of insulation is not important.

(Continued on page 312)

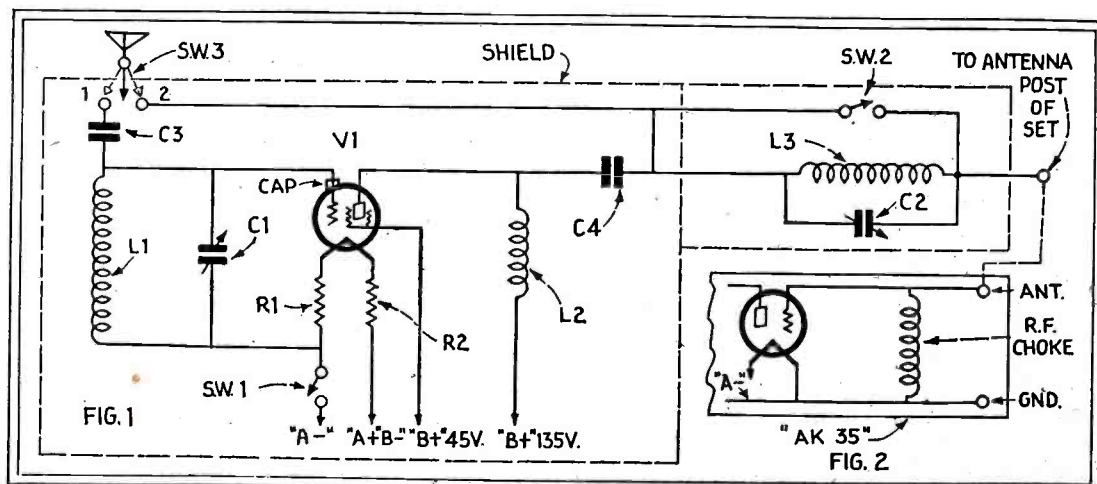

Fig. 1

While Mr. Henning obtained good results with an unshielded model, it is advisable, particularly where there are locals, to shield both the amplifying and the wavetraps circuit, and to have the connection to the "Antenna" post short. At the lower right, the aperiodic input of a popular commercial receiver, showing how the "Better Booster" is coupled to its first tube.

More Power For the Sound Installation

From the "250" power tube, the centralized radio installation steps up to 50-watt tubes for more power and fidelity

By LUDWIG ARNSON*

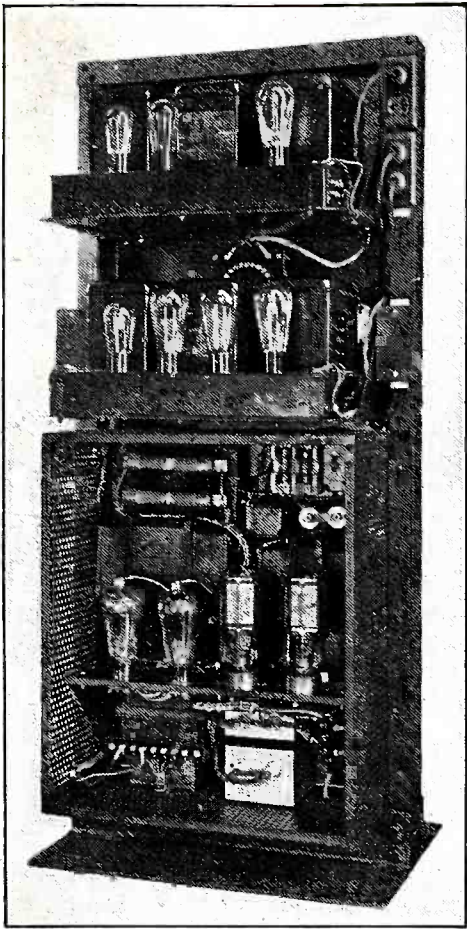

A fifty-watt "powerizer" installation, as seen from the back of the control panel. A safety device automatically turns off the power when the screen is opened.

IN dealing with sound requirements, as with illumination, our ideas are being revised—decidedly upwards. Just as we started out with the candle as the unit of illumination, only to find that at least 50 candles represent the practical unit of present-day light, so in sound generation and distribution we began with a watt or two, only to find through actual experience that many times that much power is required for satisfactory service.

Just how much power is required for a satisfactory sound system? Well, it is entirely a question of the work to be done, or, in other words, the amount of air to

be set in motion, which means the size of the room or the area outdoors; the degree of volume desired, which means the intensity of the sound waves as they reach the listener, the absorption of the sound, which must be overcome by a satisfactory margin, since absorbed sounds are lost sounds; and the degree of permissible distortion, based on the musical appreciation of the listeners. Sound systems are—or at least should be—rated on the basis of *undistorted output*. By that term, we mean an output of such fidelity of tone that the most cultivated ear fails to detect any signs of distortion. Undistorted output, therefore, is quite different from the term, *power output*.

The undistorted output may be only one quarter that of so-called power output; although the proportion is entirely one of distortion standard. It is this matter of providing undistorted output, rather than mere noise, which results in the wide discrepancy in the prices and sizes of amplifiers of supposedly the same power rating, since one may be based on *undistorted output*, or only a fraction of the total power output of the amplifier, while the other may be based on practically the full power output.

Proper Use of Power

As listeners have become more critical of electrically reproduced speech and music, the percentage of available undistorted output to total power output has steadily de-

clined. Therefore, the best types of power amplifiers are far larger, more elaborate and more costly, for a given purpose, than those of lower acoustic standards. Hence the recent appearance of the 50-watt "powerizer" or power amplifier, in place of the 10-watt and 15-watt installations heretofore considered ample. It is not so much the gain in total power output that is being sought, but, rather, the use of a smaller percentage of the total power output in achieving the highest possible fidelity in the reproduction, that is the long-sought goal.

Speaking in terms of undistorted output, it is interesting to note that the average home living room requires only 1.5 watts for full and realistic rendition of radio and phonograph music. An output of 2.5 watts is quite sufficient for the small auditorium with a maximum of 300 people. An output of 10 watts is sufficient for the requirements of the large theatre or auditorium, or for a concentrated group of listeners outdoors. For scattered listeners outdoors, or for the audience of the largest auditoriums, where the electrical voice must dominate all other noises, the 50-watt amplifier now comes into its own, where real speech and real music, rather than mere noise, are demanded.

In order to appreciate more fully the meaning of amplifier output in terms of
(Continued on page 315)

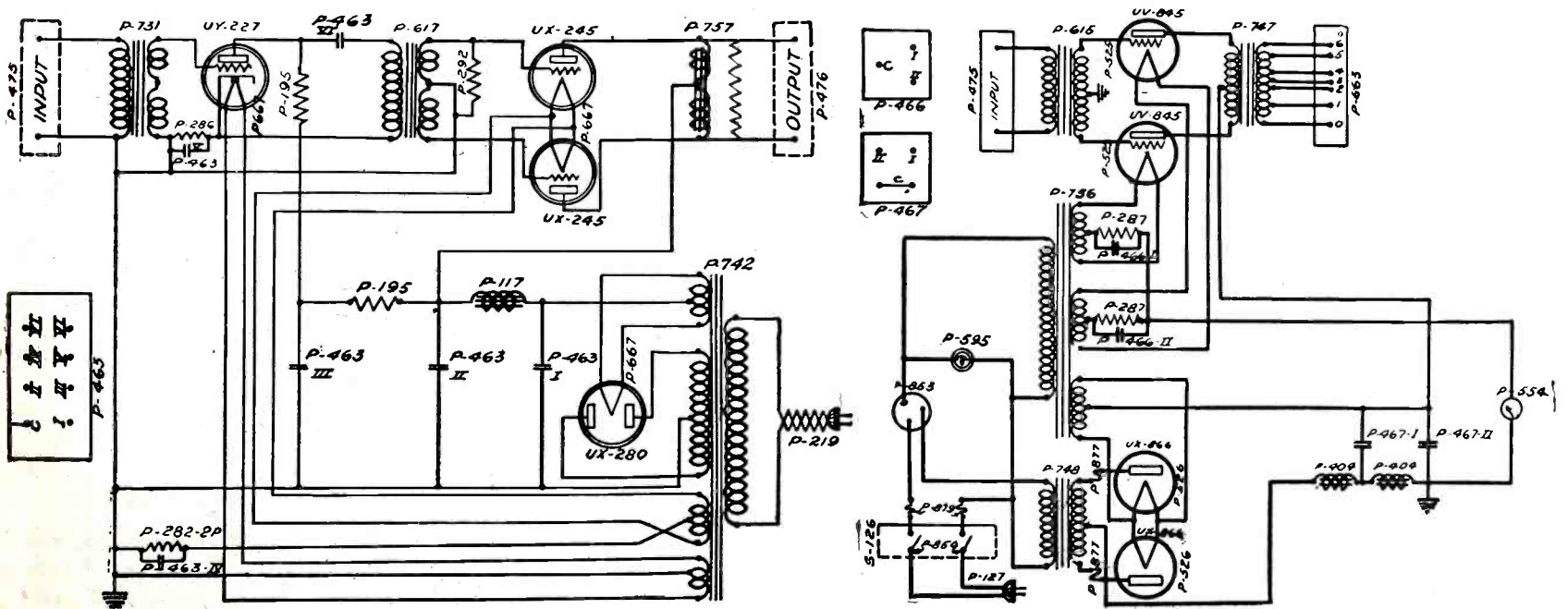

The circuit diagram of a 50-watt sound installation, suited to a large auditorium, a hotel, or outdoor work. The complete unit at the left, with two stages of audio (the second push-pull '45s) is here employed as a "driver" to feed into the third stage. The last, shown in detail at the right, is visible at the bottom of the panel pictured above. The former unit is the "Model PXP245 Driver"; the latter, the "Model P50W Power Amplifier."

* Vice-Pres., Radio Receptor Company.



SPECIAL NOTICE TO CORRESPONDENTS: Ask as many questions as you like, but please observe these rules:

Furnish sufficient information, and draw a careful diagram when needed, to explain your meaning; use only one side of the paper. List each question.

Those questions which are found to represent the greatest general interest will be published here, to the extent that space permits. At least five weeks must elapse between the receipt of a question and the appearance of its answer here.

Inquiries can be answered by mail only when accompanied by 25 cents (stamps) for each separate question.

Other inquiries should be marked "For Publication," to avoid misunderstanding.

Replies, magazines, etc., cannot be sent C. O. D.

STEWART-WARNER "SERIES 950" A.C. SCREEN-GRID SET

(93) Mr. Carol A. Fielding, Highland Park, Mich.

(Q.) A Stewart-Warner screen-grid radio set, the "Series 950 A.C." has developed a case of circuit oscillation. Please advise as to the probable cause of this effect in the "950;" the means to correct it; and the procedure in phasing the several tuned circuits.

(A.) Although the request is terse and appears to be a simple one, the answer must necessarily be rather extensive.

The circuit of this receiver is shown below; referring to this diagram, the 0.1-mf. condenser bypassing the screen-grid of V1 may be the cause of circuit oscillation over the entire waveband. It is the smaller of the two condensers fastened to the front side of the chassis frame (in earlier models it was riveted directly to the screen-grid prong of the second R.F. socket) and in appearance resembles a fire cracker. The quickest way to check this condenser is to substitute another (of the same capacity or larger) definitely known to be good.

Circuit oscillation on the higher wavelengths may be due to an open R.F. plate bypass condenser. This 0.25-mf. condenser is the large, round one fastened to the base and next to the R.F. coils.

Circuit oscillation throughout the tuning range, accompanied by a blurred reception, may be due

to an open in the fixed condenser bypassing the R.F. grid bias resistor.

It is to be noted that a screen-grid potential greater than 85 volts will probably cause circuit oscillation. The cause of excessive voltage at this point may be due to low resistance in the purple resistor (its value should be 20,000 ohms) in the center of the five colored carbon-rod resistors mounted on one strip.

Each of the tuning condensers is grounded through an individual contact shoe, which makes connection with the rotor shaft. If this contact collects a considerable amount of dirt, loosens, or becomes corroded, circuit oscillation may result.

Coupling through external wires may cause circuit oscillation, due to this feedback. Such coupling may exist where the aerial comes close to the terminal strip behind of the set, or where it crosses either the reproducer leads or the 110-volt current supply cord. Once again, it is considered advisable to point out that a poor ground may cause circuit oscillation; this is more true of the "950" than of many sets of lesser sensitivity. The Service Man perhaps is unaware that a simple, but infallible, test may be made to determine whether the ground is a poor one, or whether external coupling exists. Just connect an .006- to 0.1-mf. condenser inside the set, from the frame to one of the 110-volt power leads at the soldering lug on the resistor terminal strip to which the

110-volt cord is connected. If, after reassembling the receiver carefully, all traces of circuit oscillation are gone, the original cause was unquestionably either outside feed back or a poor ground. Having determined that outside leads run directly to the set and are not coupling back to other parts of the circuit, change the ground connection.

Exceptional amplification at the higher wavelengths may result in circuit oscillation at the low-frequency end of the tuning scale; a condition which is seldom apparent unless the set is tuned exactly to the station and the volume control is turned on full. To cure this trouble, first remove the bottom metal plate of the set.

Note the three leads running under the large filter condenser, from the R.F. coils to the plate of the screen-grid tubes. If these leads are encased in metal braiding, the braiding should be pulled out more; so that the wire is completely shielded. If these leads are encased in brass channel-strips, the filter condenser should be removed, and the brass clinched over the wires with a pair of pliers.

Now, when replacing the filter condenser, omit the cardboard strips between the shielded leads to make certain that the pressure on the leads is sufficient to insure a perfect ground. (For the same reason, if the condenser is of the large black type, it should be reversed, so that the paper back

(Continued on page 316)

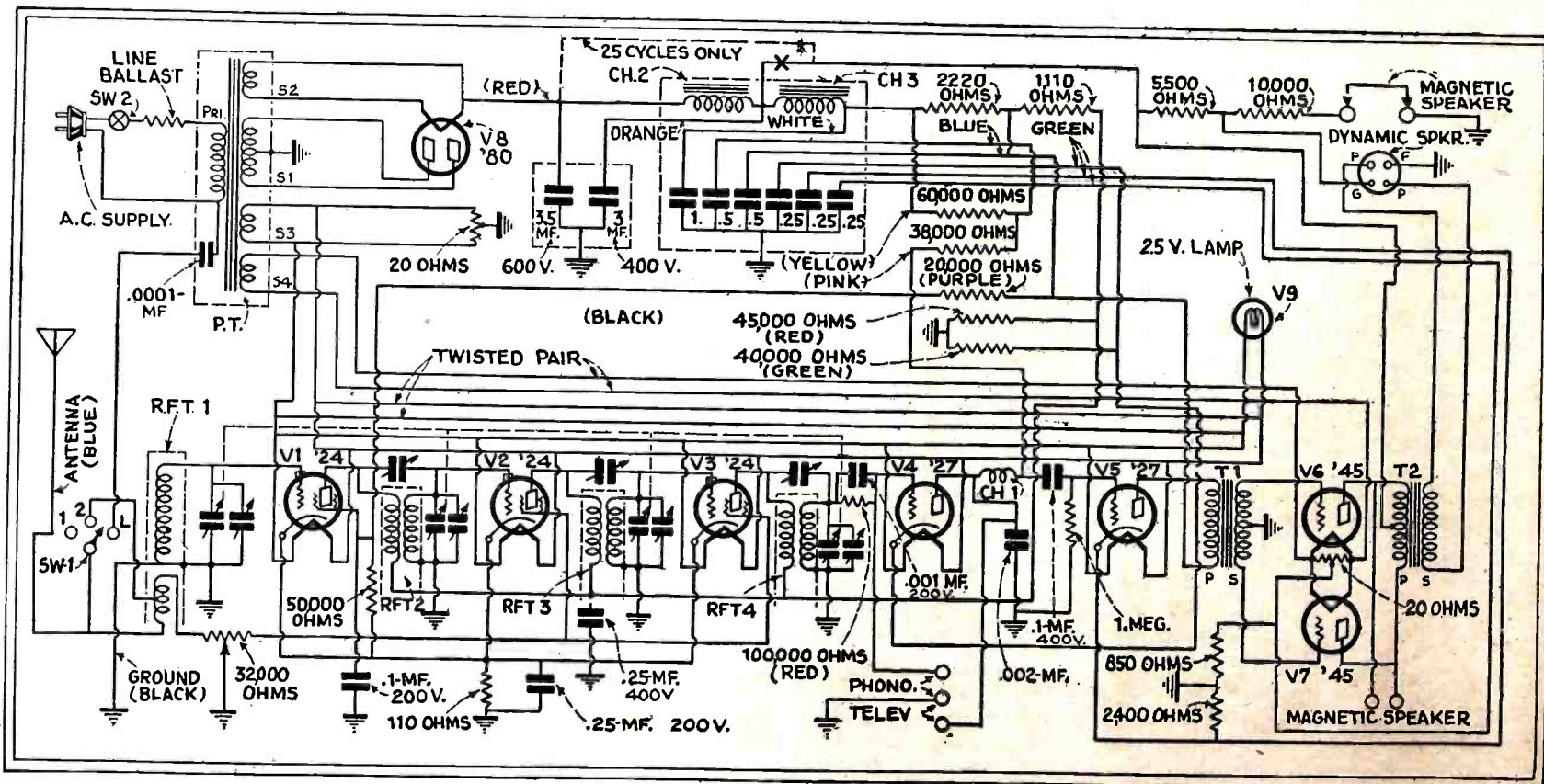

(Fig. Q.93) The screen-grid Stewart-Warner "Series 950" with its power pack, in schematic form: the "television" jacks permit using this audio channel with a short-wave tuning unit. The jumper at the upper right ("Speaker Link") is taken out when the dynamic reproducer is used with this model.

RADIO NEEDS YOU!



*Radio Inspectors
\$2000 to \$4500
a Year*

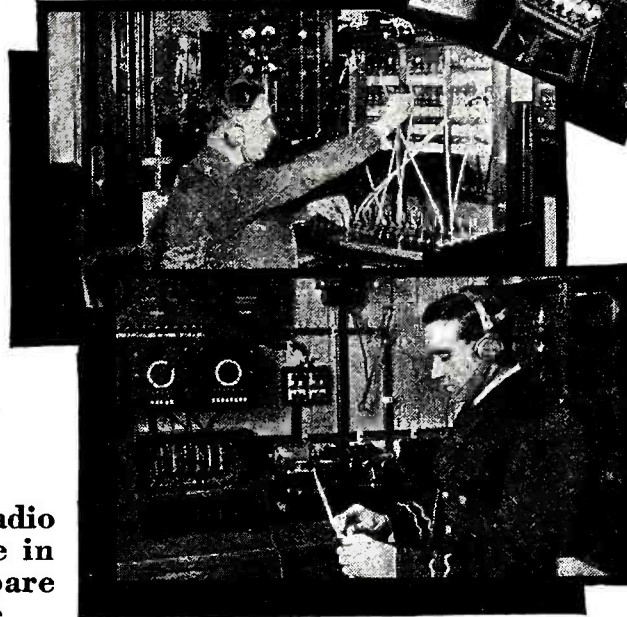

*Radio Broadcast
Mechanics
\$1800 to \$4800
a Year*

...and YOU Need Radio!
Many opportunities for service men, mechanics, radio operators for ship, shore and broadcast stations

MANUFACTURERS and broadcast-ing stations are seeking trained RCA Institutes men. Millions of sets need servicing... thousands of ships require experienced operators... Never before was there an opportunity like this.

The Only Radio Course Sponsored by Radio Corporation of America

RCA Institutes (A Division of Radio Corporation of America) conducts courses in every branch of Radio and assists graduates in obtaining employment. Why wait another day... See for yourself what Radio will do for you...

Study Radio under the direction of RCA... the organization that sets the standards for the entire radio industry... Study under the direction of RCA experts... Learn the "why" as well as the "how" of radio problems... by actual experience with the remarkable outlay of apparatus given to every student.

Graduates of RCA Institutes Find It Easier to Get Good Jobs

Students of RCA Institutes get first-hand knowledge, get it quickly and

Study Radio at Home in your Spare Time

Increase your earning capacity by learning Radio under the direction of RCA experts. Ask about amazing outfit of special radio equipment supplied to every student of the RCA Home Laboratory Training Course. See for yourself how you too can tune-in on success by studying Radio in your spare time.

Study Radio

by taking Radio Study Course at any of these RCA Institutes resident schools (classroom instructions)... RCA experts instruct you in every phase of radio... The man who trains TODAY will hold down the big-money job of the future.

RCA Institute resident schools that give classroom instructions are located in the following cities:

- New York
75 Varick Street
- Boston, Mass.
899 Boylston Street
- Philadelphia, Pa.
1211 Chestnut Street
- Baltimore, Md.
1215 N. Charles Street
- Newark, N. J.
560 Broad Street
- Chicago, Ill.
222 North Bank Drive

get it complete. Success in Radio depends upon training and that's the training you get with RCA Institutes. That's why every graduate of RCA Institutes who desired a position has been able to get one... usually in from three to ten days after graduation. That's why trained graduates are always in demand!

Send for FREE BOOK

...Or step in at any of our resident schools and see for yourself how you too can quickly place yourself upon the road to success in Radio... how you can speed up your earning capacity... earn more money than you have ever earned before. Come in and get our FREE BOOK or send for it by mail. Everything you want to know about Radio. 40 fascinating pages packed with pictures and descriptions of the many opportunities in this fastest growing industry of today.

Send for Free Book Today!

RCA INSTITUTES INC.

A Division of Radio Corporation of America

RCA INSTITUTES, Inc.
Dept. SRA-11, 75 Varick Street, New York

Gentlemen: Please send me your FREE 40-page book which illustrates the opportunities in Radio and describes your home laboratory methods of instruction.

Name.....

Address.....

.....

Occupation.....

What's NEW in RADIO?

How would you like to be posted on the new things and new developments in radio, just as soon as they come out? How would you like to receive mail from the country's leading radio manufacturers, wholesale radio mail order houses and publishers in the radio industry? How would you like to have access to the most complete radio data files ever compiled, containing all the important facts in every phase of radio progress? How would you like to receive regularly, catalogs, folders, circulars, price lists, bulletins, samples galore, etc., keeping you in close touch with the happenings in the radio industry for an entire year? This is only part of our complete service to you.

Would you like to locate a manufacturer of a certain product? Would you like to know the name of a jobber near you handling some particular item you may be interested in? Let us solve these questions for you.

No live radio dealer, fan, amateur, experimenter or professional can afford to be without our comprehensive service.

Our business is the nerve center of the radio industry, reaching out everywhere, collecting data from every available source, maintaining the most complete service of its kind in the world.

all for \$1

You will realize that the amount we spend for postage alone does not cover the charge for our service. The \$1 subscription fee barely pays the necessary expenses entailed in mailing.

A subscription to our service will actually save you many times the small cost of \$1.00.

If there is any additional information you may require before subscribing, write for further details.

This Handy Practical Portfolio FREE!

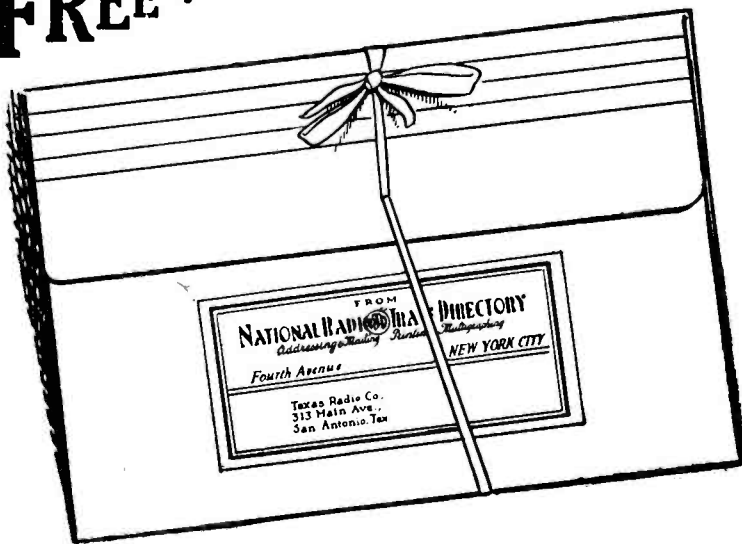

Every subscriber to our service receives one of these 10 by 15 inch accordeon portfolios made of a durable material, in which to save the valuable data we send you.

NATIONAL RADIO TRADE DIRECTORY
Addressing & Mailing Printing & Multigraphing
303 FOURTH AVENUE
NEW YORK, N. Y.

Just Pin Dollar Bill to this form, fill in and Mail at once!

Date.....

NATIONAL RADIO TRADE DIRECTORY,
303 Fourth Avenue, New York.

Gentlemen:

Enclosed please find \$1.00 for one year's subscription to your "Big Mail" and "Radio" Information Service. It is understood that you are to put my name on your stencil list to receive mailings, including catalogs, bulletins, price lists, samples, etc. I am also to receive free a 10 by 15 inch accordeon portfolio.

NAMEADDRESS

CITYSTATE

The Radio Craftsman's Own Page

A SIX-COIL SWITCH

Editor, RADIO-CRAFT:

I have made a coil-switching arrangement for my short-wave set which may be of interest to other RADIO-CRAFT readers. It is possible to add another ring to those shown, if an aerial winding is to be used.

The set is very compact; the panel is only 7 x 10, and the baseboard 9 1/2 x 9 1/2. It was built originally as an adapter. I intend to rebuild it and put the coil-switch knob in the center of the panel. With a set like the Pilot "Super-Wasp," two switches of this kind could be used, one for each stage; and operated with a single dial.

I have found too that, by connecting a wire to my short-wave set's plate post, while I am using the phones, and the other end of the wire to the corresponding "P" post of the first audio transformer in my set, I get loud-speaker volume, even though the connecting wire runs through several rooms. The broadcast set is a 6-tube Fada neutrodyne. The same result is obtained by using a winding of an A.F. transformer, or any choke, in place of the phones.

The switchblock of my combination is made of a piece of fiber, with holes drilled into it. In this there are four spring contacts, each made of two pieces of brass rod, which are forced apart by springs, and

tory, is to have a high-voltage wire from the "B" battery touch some part of the circuit where it does not belong, and burn out one or more tubes.

It has often been suggested that a resistance unit be inserted in each "B" battery lead, to limit the current which could flow in case of a short-circuit; but until recently no resistance units suitable for the purpose have been available.

Fixed resistors are unsuitable; because a value of several hundred ohms is necessary to limit the flow of current, and this is high enough to interfere with normal operation. What is needed is a ballast resistor with a very low value when cold, and a comparatively high one when hot.

This property is found in the filaments of new Mazda lamps, now available at the low price of 20 cents each. The 115-volt, 25-watt lamp has a cold resistance of but 42 ohms; but when it is connected across 45 volts, the value rises to 360 ohms, and will thus limit current flow to 125 milliamperes, a safe value for the filament of a '22 tube.

If it is desired to protect '99s or other tubes of 60-milliamper filament rating, 15-watt Mazdas should be used. These have a resistance as low as 75 ohms when cold, rising to 638 ohms when heated. This will limit the current flow to 70 milliamperes,

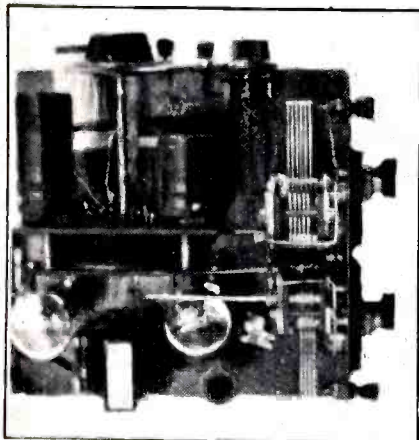

Mr. Kuhny's short-wave set is shown above, with its fixed coils at the upper right.

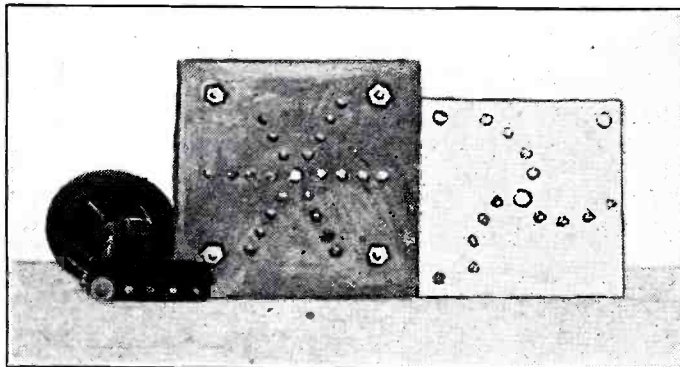

Instead of rotating the coil assembly, in this set a rotating multiple switch is used. The switchblock at the left has four contact points on each side; the large plate mounts the coils; and the switchpoints on the smaller connect with four concentric metal rings.

connected electrically by short flexible wires. These spring contacts connect four metal rings with switchpoints, formed by flat-headed screws, countersunk into the bakelite plate.

JOHN KUHN, Y,
758 College Avenue,
Winnipeg, Manitoba,

not too far above normal for these tubes.

I have not found a case where the added resistance was objectionable or even noticeable; but, if it should be, the simple remedy is to by-pass the audio-frequency current around the "B" battery supply by the use of one or two 2-mf. condensers.

FREDERICK E. WARD,
Box 25, Cataumet, Mass.

(The by-passing of the "B" battery and its ballast-resistor lamps may well be done in the manner diagrammed (Fig. 2) so that each plate circuit—detector, amplifiers, and power tube—will have its own shunt to "B" minus, as in a well-made socket-power unit.—Editor.)

MAKING SELENIUM LIGHT-SENSITIVE CELLS

Editor, RADIO-CRAFT:

Although the selenium cell has found little application at audible frequencies (such as are encountered in sound-picture operation) because of the "lag" of selenium at these frequencies, nevertheless this substance is

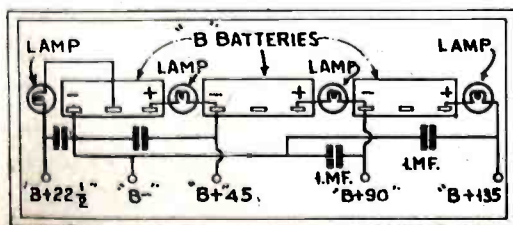
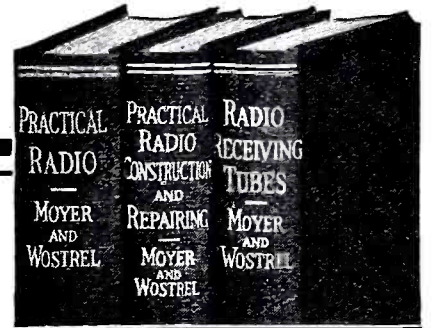

Fig. 2

These batteries are fused with small Mazda lamps.

The answers to your questions on building, testing and repairing radio sets



The three volumes of this Library cover the entire field of building, repairing and "trouble-shooting" on modern radio receivers. The Library is up-to-the-minute in every respect and is based on the very latest developments in the design and manufacture of equipment. The rapidly-growing interest in short-wave reception is thoroughly covered in a complete section which deals with the construction of this type of apparatus.

Radio Construction Library

By JAMES A. MOYER and JOHN F. WOSTREL

Faculty, University Extension, Massachusetts Department of Education

Three Volumes — 993 Pages, 6x9
561 Illustrations

VOLUME I: presents the fundamental principles of radio so clearly and simply that anyone of average training will be able to read, understand and apply them. In one chapter alone, it gives actual working drawings and lists of materials for the construction of eight typical sets.

VOLUME II: fully discusses all of the elementary principles of radio construction and repair. An explanation of the necessary steps for "trouble-shooting," repairing, servicing and constructing radio sets successfully.

VOLUME III: covers the essential principles underlying the operation of vacuum tubes in as non-technical a manner as is consistent with accuracy. It discusses the construction, action, reactivation, testing and use of vacuum tubes; and an interesting section is devoted to remote control of industrial processes; and precision measurements.

EXAMINE these books for 10 days FREE

This Library is not only a thorough home-study course, but a handy means of reference for the more experienced radio experimenter, repair man, and radio shop-owner. To these men, as well as to those who desire to advance in the radio profession, this offer of a 10 days' Free Examination is made.

Simply clip, fill in, and mail this coupon

McGRAW-HILL
FREE EXAMINATION COUPON

McGRAW-HILL BOOK COMPANY, INC.,
370 Seventh Avenue, New York.

Gentlemen:—Send me the new RADIO CONSTRUCTION LIBRARY, all charges prepaid, for 10 days' Free Examination. If satisfactory I will send \$1.50 in 10 days, and \$2.00 a month until \$7.50 has been paid. If not wanted I will return them at your expense.

Name

Home Address

City and State

Position

Name of Company.....R.C. 11-30



For SERVICE MEN

TONE TEST DEMONSTRATION RECORD

ENABLES YOU to SERVICE SETS in SIX MINUTES

SERVICE MEN—HERE IS A PRACTICAL TIME AND MONEY SAVER FOR YOU. With the new TONE TEST DEMONSTRATION RECORD you can instantly detect faults in cabinet construction and rattles in metal parts of a chassis. When this demonstration record is played the low rumbling notes will show up defects in cabinets. Loose parts start into vibration. When the high shrill notes are played you can instantly detect loose parts in the chassis. The frequency range of this TONE TEST DEMONSTRATION RECORD enables you to make a RAPID and COMPLETE service job of any radio receiver. ALL IN SIX MINUTES—and you assure yourself that the set is in PERFECT condition before it goes on the service floor. Defective tubes can be found when you play this record. It's a real help to any service man. Ask those who are using this record.

Recorded and produced for the publishers of "RADIO" and sold to you on a money-back guarantee.

Only \$1.00 POSTPAID IN THE U.S.

SPECIAL INTRODUCTORY OFFER

Buy a standard package of 6 of these records and give one to each of your salesmen. SIX RECORDS FOR \$5.00, postpaid.

—Shipments made on same day your order reaches us . . .

RADIO

Pacific Building, San Francisco, California.

Send _____ Demonstration Records to me immediately upon receipt of this order.

I enclose \$ _____ in full payment. (Prices: \$1.00 each, or \$5.00 for six)

G

CHECK HERE IF C. O. D. SHIPMENT IS WANTED

Name.....

Street and Number.....

City.....

State.....



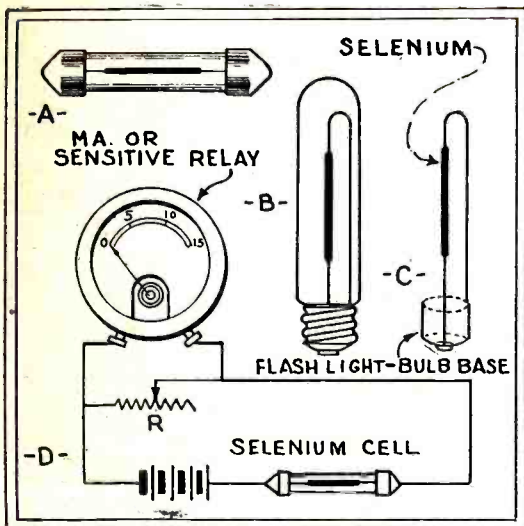

Fig. 1

Two handy methods of mounting a selenium cell, at A and B; the latter uses a flashlight-bulb base C. The standard circuit is given at D.

a favorite with the experimenter on photo-electricity; because selenium cells are capable of generating enough current to operate a sensitive relay directly, without the intervention of a stage or two of amplification, as when a gas tube is used. The beam from a flashlight at a considerable distance is sufficient illumination to operate the circuit, in most cases.

The writer has made four of these cells since January; only two of which were satisfactory, because of lack of experience.

Selenium, obtainable from any large chemical supply house, is placed in a pyrex test tube and heated in an electric furnace or over a Bunsen flame to a little above its melting point; which is 217°C. or 422°F.

This process should be carried out under a hood or in the open air; as the fumes of the selenium are poisonous, care should be taken not to inhale them.

After the selenium is heated it should be allowed to cool slowly; and, as the temperature decreases, it becomes more plastic. Now, by turning the tube nearly upside down, the selenium may be poured in long cylindrical threads onto a piece of glass or mica that has been slightly warmed to the same temperature.

The diameter of these threads depends upon the temperature; those most suitable, when made into cell form, have a length of about 3/4-inch and a diameter of about 1/25-inch.

Annealing is the next step. This makes the selenium light-sensitive.

The selenium threads having been placed on a sheet of glass or mica, this sheet is next placed on a copper heat-diffusing plate. An open flame or electric heater heats this plate, on which is placed a thermometer. The temperature is now gradually brought up to about 130 deg. Centigrade (266 deg. F.); when the selenium changes from a shiny black mass to a dull gray, crystalline, light-sensitive substance.

Now, slowly raise the temperature toward the melting point, until the threads are entirely crystallized.

When the first signs of melting are observed (that is, the crystalline structure shows signs of disappearing, as observed through a magnifying glass), two platinum or nickel wires, which have been previously prepared, are stuck each about 1/8-in. into one of the threads; and the temperature is

immediately lowered about seven degrees. Keep the mass at this heat for about 30 minutes. Then gradually lower the temperature to about 180 degrees Centigrade (357 deg. F.); and hold at this temperature for several hours; finally lowering to room temperature.

Burnt-out filament ballasts or grid leaks furnish good tubes for mounting the selenium filament. The tubes are to be capped, and the leads on the filaments soldered to these caps (through which the leads should protrude). This is shown in Fig. 1 at A.

Another protective mounting includes a perfume bottle (as shown at B), in the neck of which is mounted the base of a flash-light bulb (C) to which the leads of the selenium filament have been soldered; sealing wax will be quite satisfactory as the seal.

The completed cell usually has a resistance of about 1/2-meg. When it is connected as shown at D (Fig. 1), a slight current will be indicated (the "dark current") if the cell is shielded from light; a greatly increased reading is obtained when the cell is exposed to light. The resistor R is a meter safety shunt.

BERNARD T. RING.

East Long Branch, N. Y.

Voltage Distribution

(Continued from page 264)

does not equal the result calculated by Ohm's law, check for a bleeder resistance, connected between the common junction of the cathodes and their resistor and some part of the plate or screen-grid circuits.

Whereas it was customary, in days past, to operate all radio-frequency amplifying tubes at like values of plate voltage, such design is not general today. Two tubes in a four-tube system may be operated at one plate voltage, and the other two tubes at a higher voltage.

After all is said and done, such arrangements do not introduce new electrical laws; all are governed by laws developed years ago. The marked difference between the old and the new is nothing more than the use of a greater number of resistors and closer linking of circuits.

Such unconventional forms of voltage distribution mean much when testing receivers. An open plate circuit in a conventional system would interfere with the grid bias. In many systems used today, wherein a bleeder resistance, connected between the "low" end of the plate winding and the junction between the grid-bias resistor and the cathode, supplies current to the grid-bias resistor, a bias will be evident without a plate-current indication upon that meter.

Times are changing and systems are altered. Take nothing for granted, and visualize new methods of connection.

The Flying Service Man

(Continued from page 267)

when I did work overtime, I had actually accomplished less work at the end of the week.)

8:30 a.m. I reported at the shop, turned in the previous day's reports, and received orders for the day. I drew supplies from the stock room, and arranged the calls in

New Developments!

Complete Instructions and Data on All Recent Radio Inventions Now Yours for Ready Reference in This One Big Guide Book of Radio

BYRD'S ANTARCTIC RADIO EQUIPMENT—Receivers, transmitters and latest navigation aids used on this epochal flight fully described.

TELEVISION—Mr. C. F. Jenkins, father of television and radio movies, gives you in his own words complete directions for building practical television equipment.

INTERFERENCE ELIMINATION—New methods systematically outlined by W. F. Fleming, radio engineer.

RADIO AUTO-ALARM—Description of new device for ships which keeps the SOS watch while operator is off duty.

SHORT-WAVE APPARATUS—Commercial and amateur, described and illustrated.

NEW BROADCASTING EQUIPMENT—Temperature-controlled Piezo crystal oscillator; 100 per cent. modulation panel and other new apparatus.

—and these are only a few of the NEW subjects added to the most complete radio handbook ever published—

THE RADIO MANUAL

A Handbook for Students, Amateurs, Operators and Inspectors

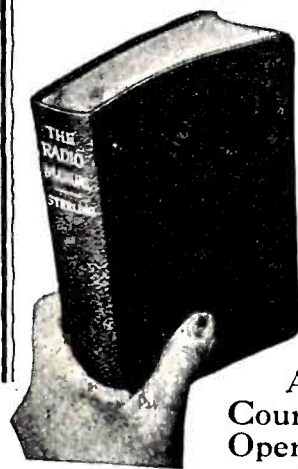

Here's the answer to every question about the principles, operation, and maintenance of apparatus for radio transmitting and receiving. Important new chapters have been added to bring it right up to the minute. Many new photographs and diagrams have been included. It is now more than ever the one complete handbook covering the entire radio field.

A Complete Course in Radio Operation in ONE VOLUME

Prepares for Government License

20 big chapters cover: Elementary Electricity and Magnetism; Motors and Generators; Storage Batteries and Charging Circuits; The Vacuum Tube; Circuits Employed in Vacuum Tube Transmitters; Modulating Systems and 100 Per Cent. Modulation; Wave-Meters; Piezo-Electric Oscillators; Wave Traps; Marine Vacuum Tube Transmitters; Radio Broadcasting Equipment; Arc Transmitters; Spark Transmitters; Commercial Radio Receivers; Marconi Auto-Alarm; Radio Beacons and Direction Finders; Aircraft Radio Equipment; Practical Television and Radio Movies; Eliminating Radio Interference; Radio Laws and Regulations; Handling and Abstracting Traffic.

Prepared by Official Examining Officer

The author, G. E. Sterling, is Radio Inspector and Examining Officer, Radio Division, U. S. Dept. of Commerce. The book has been edited in detail by Robert S. Kruse, for five years Technical Editor of Q S T, the Magazine of the American Radio Relay League, now Radio Consultant. Many other experts assisted them.

Examine it FREE!

The latest edition of "The Radio Manual" is now ready. Nearly 800 pages; 369 illustrations. Bound in flexible Fabrikoid. The coupon brings the volume for free examination. Within 10 days you may return the volume or send the price of \$8.00.

MAIL THIS COUPON

D. Van Nostrand Co., Inc.,
 250 Fourth Ave., New York.
 Send me the Revised Edition of THE RADIO MANUAL for examination. Within ten days after receipt I will either return the volume or send you \$8.00, the price in full. (R.C. 11-30)
 Name
 Street and No.
 City and State
 Business connection



TOBE UTILITY CONDENSERS

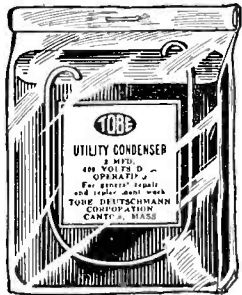

Tobe Replacement Utility Condensers are designed especially for power pack repair work. They are protected from moisture by a new wax coating process recently developed to meet the requirements of condensers for this type of work.

The terminal arrangement is especially desirable for replacement work. These Utility Condensers are furnished with a looped tin wire connected to both condenser terminals, which may be cut to the desired length when the condenser is used.

These condensers are furnished in various capacities and working voltages, making it possible to rebuild and repair any condenser or condenser block. Their compactness makes it very easy for a serviceman to fit them into the space formerly provided for the condenser block.

Each condenser carries a label giving its capacity and working voltage, and is packed and sealed in individual moisture-proof container. They are without exception the most universal line of condensers yet designed and will stand up for a long period of use.

Type No.	Capacity	Working Voltage D.C.	Size	List Price	Type No.	Capacity	Working Voltage D.C.	Size	List Price
331	1 mfd.	300 v.	1 3/4 x 1 3/4 x 3/8	\$0.75	662 (new)	2 mfd.	600 v.	2 5/8 x 2 5/8 x 1 1/2	\$2.85
332	2 mfd.	300 v.	1 3/4 x 1 3/4 x 3/4	1.45	881 (new)	1 mfd.	800 v.	2 5/8 x 2 5/8 x 1	1.70
441	1 mfd.	400 v.	1 3/4 x 1 3/4 x 1 1/8	1.10	882 (new)	2 mfd.	800 v.	2 5/8 x 2 5/8 x 2	3.35
442	2 mfd.	400 v.	2 5/8 x 2 5/8 x 7/8	2.15	1101	1 mfd.	1000 v.	2 5/8 x 2 5/8 x 1 5/8	1.75
661	1 mfd.	600 v.	2 5/8 x 2 5/8 x 3/4	1.45	1331	1 mfd.	1300 v.	4 1/4 x 3 x 1 1/4	2.25

TOBE PIG-TAIL RESISTORS

Fused-Metallic

Individually bridge-calibrated.
 Tungsten-nickel-cadmium-coated.
 Unchanging with age.
 Values ENGINEERED, not sorted.
 Pigtailed.
 Fits standard mountings.
 Heavy internal fused-metallic contact.
 Unexcelled for Loftin-White direct-coupled circuits.
 For meter-multiplier work an exceptionally accurate resistor, calibrated to within one-half of one per cent. will be furnished at three times the regular list price.



TOBE 2-WATT RESISTOR

200 ohms to 50,000 ohms..... \$0.75
 100,000, 250,000, 500,000 ohms, 1 to 10 Megs., each..... .50

TOBE 5 WATT, FITS ALL STANDARD MOUNTS

100 ohms to 30,000 ohms..... \$1.10
 50,000 ohms90
 100,000 ohms80
 1/4, 1/2 and 1 Meg. (Long Type)..... .80

TOBE 10-WATT RESISTOR

200 ohms to 25,000 ohms..... \$1.25
 10,000 ohms 1.25
 50,000 ohms 1.10
 100,000 ohms 1.10
 1/4, 1/2, and 1 megohm..... 1.00

The 1/4, 1/2 and 1 megohm 10-Watt TOBE Resistors list for \$1.00

Non-Inductive—Short Path—Non-Capacitive

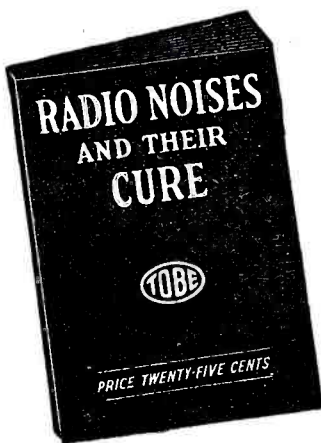

The official interference hand-book contains circuit diagrams, photographs, hints on how to correct radio interference, list of cities and towns now having Interference Ordinances, and Model Interference Law — 80 pages of worthwhile information.

Sent Prepaid for Twenty-five Cents, Coin, Stamps, Money Order or Check.

TOBE DEUTSCHMANN CORPORATION

Filterette Division

CANTON, MASSACHUSETTS

PIONEER AND LEADER IN ELIMINATING RADIO INTERFERENCE OF EVERY DESCRIPTION

proper order to comply with appointments, reduce mileage and save time.

9:00 a.m. Atwater Kent "Model 40"; complaint, "Local only and that very faint and spread over the dial." Diagnosed case en route as an open detector filament circuit or burnt-out detector tube. Visual inspection showed tube not lighted; new tube did so. Gave complete circuit and the tube test, and found everything O.K.

9:20 a.m. Victor Combination "RE-45"; complaint, "Set won't work." Diagnosed en route as any possible cause. Visual inspection revealed pilot lamp burnt out. Ran complete circuit and tube test; everything O.K. Why, oh, why, do so many people think that because the dial lamp won't light the set is dead? It's a convenience, not a necessity.

9:30 a.m. Majestic "72"; complaint, "Set plays for a while, then stops." Diagnosed as tube or resistor trouble. Visual inspection, while running tests on circuit and tubes which proved O.K., and waiting for trouble to develop, showed the detector tube suddenly cooled. Meter across filament read high, therefore trouble not in circuit to tube. Replaced with new tube; now O.K.

9:45 a.m. Atwater Kent "Model 40:" complaint, "Noisy." Diagnosed as almost anything. Visual inspection revealed no aerial; ground wire attached to ground post, thereby utilizing capacity of power transformer to 110-volt line for a pick-up.

(This showed poor salesmanship; always recommend that the customer use an antenna—it boosts the salesman's commission, gives better results and thus helps the sale.)

I explained the necessity for an aerial; this light-line gets all the static and power noises, and only part of the signal. The circuit and tubes tested O.K.

10:00 a.m. Another A. K. "Model 40:" same complaint; same conditions.

10:20 a.m. Atwater Kent "Model 65-C": complaint, "Noisy." Visual inspection showed nothing wrong. Ran complete circuit and tube test, all O.K. A slight blow on cabinet revealed microphonism in circuit or tube; tapping each tube localized trouble in '45. Switching the push-pull tubes showed that the trouble was in the same tube; removing it from the socket, and striking it a hard blow with the hand, restored the elements to their proper relative places. Another satisfied customer; because he did not want to pay for a new tube.

10:35 a.m. Majestic "Model 92"; complaint, "Set dead." Not diagnosed. Visual inspection showed burnt-out '80 tube. Replaced it and ran complete test. All O.K.

10:45 a.m. Atwater Kent "Model 40": complaint, "Set dead." Not diagnosed. Visual inspection showed a '26 in the '71A socket. Found a '71A burnt-out. Replaced tubes and ran test. Explained to customer that burnt-out tubes must be replaced with similar types.

10:55 a.m. Majestic "72": complaint, "Send Service Man." Diagnosed as "no trouble." Customer out; left note stating I would call next day. (Next day, customer wanted operating instructions; gave them and ran test, finding everything O.K.)

11:10 a.m. Rogers "Model 200A": complaint "Wants complete test." Diagnosed as another social call. Visual inspection showed loose pilot lamp; complete test showed everything O.K.

11:25 a.m. Radiola "33": complaint noisy. Diagnosed as defective tube, or no aerial as above. Visual inspection and complete test showed everything O.K. Inspected aerial; it was 200 feet long, and parallel to car-line feeders. Shifted it to right angles with the line, and shortened it to 90 feet, including lead-in. Noise reduced 80%.

11:40 a.m. Atwater Kent "Model 40": complaint, "Improperly installed." (Customer had installed set himself.) Ground wire properly attached to set, but just wrapped around radiator leg, insulation and all; no aerial. Installed ground clamp, tacked up ground wire; supplied light-socket aerial plug and advised aerial. Set tested O.K.

12:00 a.m. Dinner—very important call.

1:30 p.m. Atwater Kent "Model 36": complaint, "Burnt smell." Diagnosed as short circuit. Visual inspection showed plates of '80 red-hot. Brought set in for repair to filter condensers.

1:45 p.m. Wrong address. Phoned shop and verified address as received from customer.

2:00 p.m. Majestic "71": complaint, "Burnt-out pilot lamp." Diagnosed as burnt-out or loose. Visual inspection—burnt-out. Replaced it and ran test; all O.K.

2:15 p.m. Majestic "92": Complaint not specified. Customer declared they didn't call for service. Diagnosed as salesman worried about sale.

2:35 p.m. Rogers "490": complaint, "Set won't work." Not diagnosed. Visual inspection showed Amperites in 110-volt circuit red-hot; on removing the Raytheon tube, they became normal. Test showed shorted filter condenser; took power pack to shop for repair.

2:50 p.m. Atwater Kent "Model 40": complaint, "Improperly installed." (Customer had made his own installation; no aerial, no ground.) Installed ground wire, supplied light-socket antenna plug, and advised aerial. Ran complete test and replaced one weak '26.

3:30 p.m. Atwater Kent "Model 36": complaint, "Set dead—tube won't light." Diagnosed as open 110-volt circuit; visual inspection showed all tubes but '80 lighted. Replaced this; ran complete test, and found shorted lightning arrester. Installed a new one; now all O.K.

3:55 p.m. Victor Combination "RE-45": complaint, "It sounds awful." Diagnosed as tube trouble or open bias resistor. Visual inspection—all O.K. Aural inspection (*listening*) suggested broken diaphragm. Replaced diaphragm with new one. Tested pickup by tapping needle both ways; response one way but not the other—centralized armature. Cautioned customer against forcing pickup against turntable. Set still sounded weak: complete test showed, for the first time in my experience, that one side of the '80 had very low emission. This was not due to low A.C. voltage from one side of the secondary, nor to an unbalanced secondary. A new '80 was installed, and all was O.K.

4:45 p.m. Victor Radio "R-32": complaint, "Pilot lamp burnt out." Visual inspection showed lamp loose in socket; ran complete test. All O.K.

4:55 p.m. Victor Combination "RE-45": complaint, "Bad hum, and phonograph

NEW! NEW! NEW!



A NEW SUPER-HET BY LAFAYETTE

It's here at Wholesale! The new Lafayette Super-Heterodyne. Super-selectivity — and then some. Intermediate-frequency amplification that puts a new thrill in radio reception. The sharpest radio frequency circuits ever produced. A custom built "Super" that is breath-taking in its newness. The new A.C. operated Lafayette Super (R.C.A. licensed) is a nine-circuit, screen-grid receiver. Amazing low price. Write for particulars.

LAFAYETTE WIDE WORLD SHORT WAVE RECEIVER

Enjoy the thrill of perfect short-wave reception with the new LAFAYETTE WIDE WORLD SHORT WAVE RECEIVER. A.C. operated. Push-pull amplification. Double Screen Grid. Operates on a wave length of 9 to 550 meters. Pulls in stations all over the world—Java, Australia, Holland, England, etc. Priced sensationally low.



RUSH THIS COUPON at once!

WHOLESALE RADIO SERVICE COMPANY, 38 Vesev Street, Dept. L-17, New York.

FREE

RADIO CATALOG! New 1931 Wholesale Radio Catalog. Coupon bring yours free.

Send me a copy of your 1931 radio catalog ABSOLUTELY FREE. I am particularly interested in

- () New Lafayette Super-Heterodyne
- () New Lafayette Wide World Short Wave Receiver

Name.....
Address.....
Town..... State.....

WHOLESALE RADIO SERVICE CO. INC. 38 VESEY ST. Dept. L-17 New York

If your subscription to RADIO-CRAFT expires with this issue, or even the next, read the announcement on page 308 NOW.

FREE! RADIO BARGAIN CATALOG

ALSO FREE RADIO GIFT

Send now for this new free radio catalog which saves you many dollars on radio outfits, kits, parts, tubes and accessories! Also TIME CONVERSION CHART FREE. Tells you instantly what time it is in any part of the world! Given free if your request for catalog reaches us this month.

20th CENTURY MAIL ORDER CORP.

202 JACKSON ST., CHICAGO, ILL.

Genuine PILOT Products

Announcing ~

RADIO

Service Man's HANDYBOOK

WITH ADDENDA DATA SHEETS

THIS new book contains a tremendous amount of the most important data of every kind — several hundred illustrations, wiring diagrams, charts, on every conceivable subject pertaining to radio sets, tubes, etc. The book is live "meat" from start to finish, and contains only *practical information* on which every radio man can cash in immediately.

Just to give you a few subjects contained in the book, we mention the following:

- Prescriptions of a radio doctor
- Modernizing old receivers
- Servicing obsolete sets
- Operating notes for Service Men
- Service Men's data
- Servicing automobile radio installations
- Curing man-made static
- Causes and cure of radio interference
- Notes on repairing "B" power units
- Constructional data on laboratory equipment

- A portable radio testing laboratory
- Servicing with the set analyzer
- What and how the Service Man should sell
- Helping the Service Man to make money
- How to become a Service Man
- Servicing broadcast receivers
- All about vacuum tubes, and vacuum-tube data
- Special radio Service Man's data
- Dozens of radio service data sheets
- And hundreds of other similar subjects

\$2.00 PER COPY

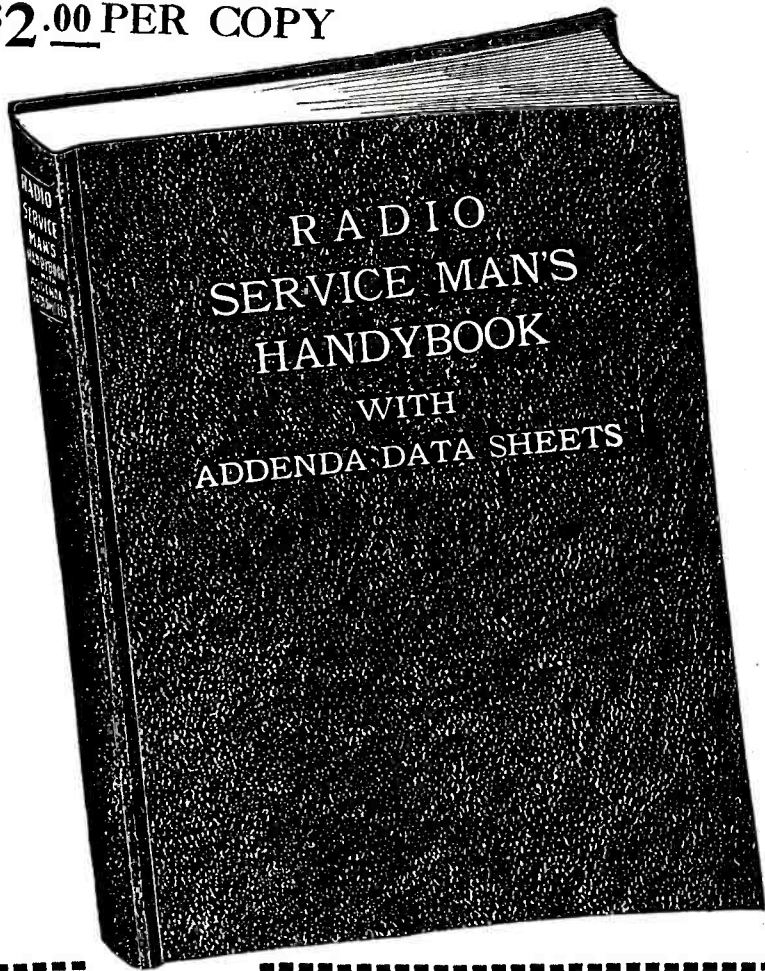

The Foremost Radio Service Authorities Have Contributed to This Book

- | | | |
|------------------|------------------|-----------------|
| C. W. PALMER | GEO. C. MILLER | H. WEILER |
| LEON L. ADELMAN | JULIUS G. ACEVES | J. E. DEINES |
| SYLVAN HARRIS | C. W. TECK | F. R. BRISTOW |
| BERTRAM M. FREED | PAUL L. WELKER | and many others |

A NEW DEPARTURE

EVERY Service Man, every radio man, every radio experimenter and every radio professional makes his own notes, draws his own circuits and writes down his own observations and his own data. For these reasons, the RADIO SERVICE MAN'S HANDYBOOK has been made in loose-leaf form. *There are supplied with this book 48 special ledger paper pages, square ruled on both sides so that you can take a leaf and place it wherever you wish, and write on it your own data.* If you wish, you can also cut out data from other publications and paste it on the sheet—placing it in its proper position in the loose-leaf book.

The total number of pages is 200 and the book contains such a wealth of radio material as you have never seen before between two covers. *Nothing like it has ever been produced.* The book is of the large size, 9 x 12 inches, and is in the same loose-leaf form as the OFFICIAL RADIO SERVICE MANUAL. It has a semi-flexible cover with gold stamping.

GERNSBACK PUBLICATIONS, INC.,
96-98 Park Place, New York City, N. Y.

RC-11

Gentlemen:
As per your special offer, I enclose herewith remittance of \$2.00 (Canada and foreign \$2.25) which pays the entire amount on your new book entitled RADIO SERVICE MAN'S HANDYBOOK with Addenda Data Sheets, in loose-leaf form, as described in RADIO-CRAFT.

Name

Street

City and State

MAIL COUPON TODAY

sounds bad." Diagnosed as hum adjustment wrongly set, or open center-tapped resistor, and pickup out of adjustment. Visual inspection, all O.K.; aural inspection, had hum. Tried adjustment, which was hard over on one side. Pickup O.K. Tone control over on bass side. Centralized tone control to customer's satisfaction. Complete circuit and tube test all O.K.

5:20 p.m. Same model: complaint "Phono O.K., radio dead." Diagnosis, burnt-out R.F. or detector tube, or defective change-over switch. Visual inspection all O.K. Ran complete test; circuit and tubes all O.K. When customer saw me shift change-over switch, he apologized, saying he had forgotten to use it. (Big tip from this customer.)

5:45 p.m. Atwater Kent "Model 55-C": complaint, "Weak." Diagnosed as weak tubes. Visual inspection, O.K.; complete test ditto. Portable broadcaster (*oscillator*) showed weak reception. Resynchronized condensers, which were badly out.

6:00 p.m. Majestic "91": complaint "Set dead above 60 on dial." Diagnosed as

condenser plates touching; visual inspection all O.K. Circuit test showed lack of bias on R.F. tubes when 60 on dial was reached, and also no plate current. Replaced equalizer on condenser shaft, so that resistance was 500 ohms at 550 kc., and 2500 at 1500 kc. Complete circuit and tube test now O.K.

6:30 p.m. Supper—very important call.

Summary

Of 25 calls, one customer was out; one didn't call, and one was not to be found at the address given. I replaced eight tubes, four pilot lamps, and one lightning arrester; made two installations, one aerial relocation, and adjusted two pickups. Trouble located in 13 instances by visual inspection. Mileage on service car, 43.3.

(Several comments on Mr. Clerk's detailed account of his experiences occurred to us while reading his article. However, we will withhold them, and ask other Service Men what service procedure and experiences of their own are suggested by this story.—*Editor.*)

The Business End of Servicing

(Continued from page 271)

will call you when they can afford the tubes, will call you back. But, if you are tactful and persistent, you can sell them the tubes while you are right on the job.

Dear Patron:

We wish to thank you for having given us an opportunity to be of service to you. We realize that a successful business can only be built on good will. Our interest in your Radio does not cease with the mere collection of the service charges. It is our earnest desire to have each machine serviced by us, act as an advertisement of our business. Now that your Radio has been placed in good working order, it will be to your advantage to keep it in this condition. You can easily and inexpensively do this by taking advantage of our monthly inspection.

This inspection service consists of a thorough checking of your Radio and all the accessories once a month. This procedure greatly reduces the repair bills that are inevitable when a Radio is neglected. The total yearly cost of this inspection service is less than it would cost to replace one part in your Radio. It has been our experience that most people do not give any attention to their Radio until it has actually stopped working. Many times during the course of our regular inspection we can detect trouble and prevent it from doing serious damage to your machine. If it were only for the sake of having your Radio always in operation when needed, it would be worth the price asked for this inspection.

May we offer you this service at the amazingly low price of \$1.50 per call? This will include checking the tubes and re-activating any that may be weak, checking the aerial installation, speaker, power unit, or other accessories, testing the speaker for tone, and making any minor adjustments that may be necessary. If you wish to take advantage of this offer, return the enclosed card and we will enter your name on our inspection list.

May we again thank you for your patronage and solicit your continued good will, and that of your friends?

Yours for Radio Satisfaction,
GRAHAM BROS.

A "bread-and-butter" letter sent after making a first call.

Mistakes to Avoid

Of course, it goes without saying that you will only ruin your business if you attempt to force tubes and accessories on people who do not actually need them. But, if a man has weak tubes in his machine and is cheating himself out of real radio enjoyment, it is your duty to him to show him and convince him that his radio can be greatly improved. This idea does not involve tubes alone, but covers any other item that the customer may need to make his reception perfect. Some owners do not know just what their receivers can do; they will go along with only half-way results. Show these people just what the possibilities are, and you will make a success of the business. Their friends will notice the difference, and this will bring you much greater returns in new business.

In servicing receivers that have some major defect, such as a burnt-out transformer, it is good general practice never to spend more than thirty minutes' time on the machine in the customer's home. They have an idea that you must find the trouble immediately. The average customer dislikes very much to have his radio torn apart in front of him. Take the set to the shop where you can work in peace, and do a much better job.

A hard and fast rule, never to be broken, is: *never, under any circumstances, take the customer's tubes with you when you take a machine to the shop for repairs.* This will save you many an unpleasant scene when you have found that there are defective tubes in addition to the trouble you have just repaired. If the customer's tubes have not left his home, there can be no question as to whether or not they are his tubes. After you return a set from the shop you can proceed as outlined above, and often make an additional tube sale.

Collect Promptly

After the job has been completed, a good practice to lead up to the question of the price and payment for the job, is to have

UNIVERSAL NEUTRALIZING and ALIGNMENT KIT FOR SERVICE MEN

(Designed by Bertram M. Freed)

Hundreds of radio Service Men have already added the No. 10 Universal Neutralizing and Alignment Kit to their servicing equipment. Neutralizing, balancing and condenser alignment of standard manufactured sets are made easier, accurate and more quickly.

Made of highest grade insulating material with nickel-plated metal nibs—for long use. Easily clipped into the pocket as a fountain pen in a single unit—smaller tool fits into the larger. This kit fits (1) Amrad, Bosch, Crosley, Earl, Fada, Freed, Freed-Eisemann, Majestic, Philco, Sparton, Stromberg-Carlson; (2) Zenith; (3) Brunswick, Colonial, Fada, Garod, Hammarlund, Radiola and Victor; (4) Magnetic end for picking up and placing small parts.

Indispensable to Service Men and guaranteed for the sets mentioned above. ORDER YOUR KIT TODAY. Sent anywhere in the U. S. upon receipt of \$2.00 money order or cash—postage prepaid.

\$2.00
Patent Applied For

SERVICEMENS SUPPLY CO.
55 DEAN STREET BROOKLYN, N. Y.

DEALERS AND SERVICEMEN

Radio Bargain News

Write for Your FREE Copy of this BIG Catalog 40 PAGES OVER 1,000 ITEMS OF REPLACEMENT PARTS FOR ALL STANDARD SETS

Free Write Now

FEDERATED PURCHASER
22A Hudson Street
New York, N. Y.

SPECIALS

FARADON CONDENSER BLOCK
Contains 1½ Mfd., 1000 Volt and 2 Mfd., 600 Volt
Fine for Filter Packs, etc.
Special \$1.75

MAHOGANY BAKELITE 1¼" KNOBS
75c. per Doz. 7c. each

BEAVER SNAP SWITCH
3 Amp., 125 Volt
\$1.50 per Doz. 20c. each

Send for our
BARGAIN BULLETIN
It will save you money!!

HARRISON RADIO CO.
189 Franklin St., Dept R, New York City

THE RADIO EXPERIMENTER'S MAGAZINE

Contains more material than a \$2.50 book, yet the price is but 50c. a copy.

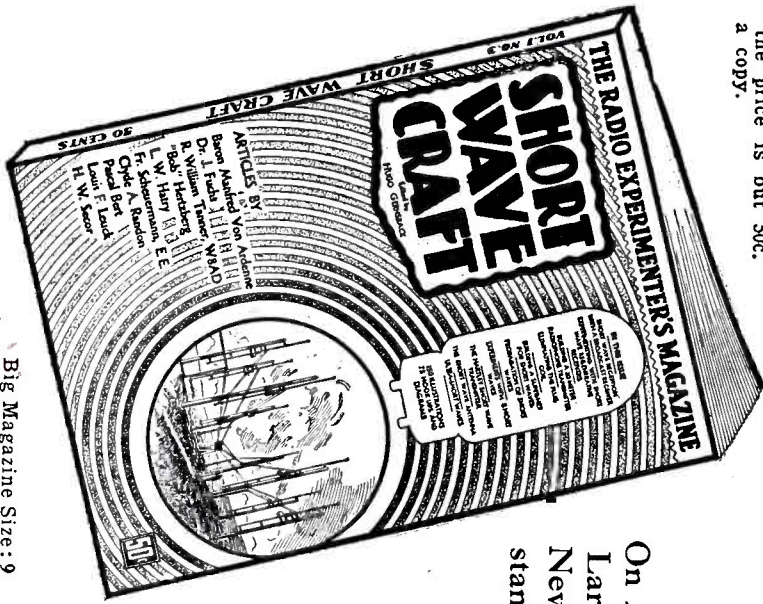

On All Large News-stands

PARTIAL CONTENTS In Short-Wave Craft No. 3 October-November Issue

SHORT WAVE CRAFT, Mr. Hugo Gernsback's latest radio magazine, has been called his greatest achievement in radio magazine publishing.

SHORT WAVE CRAFT is the one and only real big magazine on short waves you have wished for so long. HERE IS PROOF!

The Use of Ultra Short Waves for Television, by Baron Manfred Von Ardenne
Propagation of Radio Waves, by Dr. J. Fuchs
Building a 20-Meter Radio Transmitter, by R. Wm. Tanner, W8AD
How You Can Make Money by Building Short Wave Sets, by "Bob" Hertzberg
How to Build the HY-7 Short Wave Super-Heterodyne, by L. W. Hatry, Radio Engineer
Short Wave Reception with a Broadcast Receiver, by Fr. Scheuermann, E.F.E.
Experimenting with Short Wave Regenerative Receiving Circuits, by Clyde A. Randon
A Short Wave Receiver Built in a Cigar Box—An Article for the Beginner, by Louis F. Leuck
Experiments with 4-Inch Waves, by Pascal Bert
How a New York Newspaper Sent Facsimile Pages Via Short Wave Photofadio, by H. Winfield Secor, E.E.
Eliminating the Plug-In Coil—Two New Methods Illustrated and Described

Besides these outstanding features, SHORT WAVE CRAFT No. 3 is chock full of how-to-make-it and constructional articles on Short Wave Transmitters and Receivers, both for code and phone.

service report cards printed and ask the customer to sign the report. On this report you can fill in the amount of labor, tubes and accessories. (A sample card is reproduced herewith.) You can then turn to your customer and say: "Mr. Brown, that will be so much."

When doing work for people you do not know, avoid, if possible, opening charge accounts; for radio service is one of the hardest things to collect for. There is always the possibility of the set's going bad a few days after it has been repaired, for no reason of your own fault. It is just one of those things that will happen to a radio set. Your customer, however, will invariably expect you to repair it again and will usually only pay the previous charge. In this way you have to do two jobs for the price of one.

You can keep your charge accounts at a minimum if you carry blank checks on all the local banks; this will avoid those excuses that they would like to pay you but have no check blanks. Also carry enough change for at least ten dollars; this will avert the possibility of your customer saying: "Can you change ten dollars?" If you can't, you have hardly any alternative but to say, "You can just mail me your check, Mr. Brown." Those checks are usually a long time in arriving at their destination.

A good way to get around the cases where they haven't enough money in the house at the time is to say: "Oh! That's all right, Mr. Brown; but I have a call on the next street tomorrow. I'll drop in then and you can give it to me." That will usually solve this problem.

Remember that if customers owe you money, they hesitate to call you; especially if they are of the type who habitually open temporary charge accounts and conveniently forget about them. In this way you usually lose the repeat business that should be yours. Sooner than pay your old bill, they will call another man to have the set fixed, and pay him, leaving you to wait. Remember, it takes just as long to call to see a customer to collect a bill as it does to make a service call, and it is not nearly as pleasant nor as profitable. Two or three calls on a collection and you have lost all you made on it and, usually, the customer besides.

Don't get the impression that charge accounts are never to be desired. A good charge-account customer is better than a cash customer; for he will continually patronize you and, usually, make larger purchases. But limit your charge customers to those you actually know.

This, of course, applies to the larger towns. In small communities the Service Man, if he is a native, knows his people, and can use his own discretion. But remember that you can't eat, or pay your bills, with accounts that are on the books. Learn from your friend the garage man who usually displays a large sign: "ALL REPAIRS CASH."

Honesty Will Pay

Do not make a habit of "trick" repairs, such as shorting resistors, disconnecting burnt-out condensers, "shooting" transformers, or any other form of temporary repairs. If you must do this in an emergency, by all means tell the customer about it, so that you can return later and complete the job in a proper manner. Remember that you can lose much if you adopt these meth-

The question and answer box is ably edited by R. Wm. Tanner, W8AD, well-known writer and short wave expert.

Besides all these articles, there are illustrations, diagrams and descriptions of the newest Short Wave Receivers and Transmitters from the manufacturers' laboratories.

Unlike other magazines, it does not contain purely technical matter of interest only to the advanced amateur and ham. Quite to the contrary, SHORT WAVE CRAFT contains a tremendous wealth of short wave material of interest to everyone who wishes to get into short wave activities.

OVER 250 ILLUSTRATIONS, HOOKUPS, CHARTS, CIRCUIT DIAGRAMS, DOZENS OF ACTUAL PHOTOGRAPHS OF RECEIVERS, TRANSMITTERS, AND A WEALTH OF PRACTICAL STUFF.

Filled to the top with real meat—not a picture book, no mathematics, no theories that are over your head, but rather practical dope. Live "meat." That's what SHORT WAVE CRAFT offers you in every issue.

Regular Departments in SHORT WAVE CRAFT

Photographic Section—pictures of latest short wave sets and stations
Transmitters for Short Waves—How to build them

Short Wave Receivers—Construction data for all types and kinds
The Short Wave Experimenter
The Short Wave Beginner
Television on Short Waves
Short Waves for the Broadcast Listener
Ultra Short Wave Sets
Aircraft Short Wave Sets
How to Build Short Wave Aerials
Short Wave Question Box

PUBLISHED ON THE 15th OF EVERY OTHER MONTH

Extra Special Offer Void After November 15th

The regular subscription price to SHORT WAVE CRAFT is \$3.00 a year. But up to October 15th, we will accept \$1.80 for a full year's subscription (Canada and foreign, \$2.00) AND IN ADDITION will send you FREE the first two issues of SHORT WAVE CRAFT. This will give you in reality a subscription of one year and three months, value \$4.00, for \$1.80!

MAIL COUPON TODAY!

SHORT WAVE CRAFT
96-98 Park Place, New York, N. Y. RC-11

As per your special offer I enclose \$1.80, for which please enter my subscription for one year to SHORT WAVE CRAFT and send me also the first two issues gratis.

NAME
ADDRESS
CITY
STATE

ods of working. Your customer is paying you for honest-to-goodness work; see that he gets it. It is very easy for a customer to call another radio man to check up on you; and you can lose much prestige by these trick repair methods.

Many repair men give a three months' guarantee with a radio set after they have made some major repairs; such as replacements of transformers, condenser banks, etc. You will find it profitable to offer this guarantee to all your customers. You will seldom be called upon to fulfil the guarantee but, if you are called upon, be sure to live up to your word. Remember that one displeased customer can pass the word on to hundreds of people. "Bad news travels fast."

In recapitulation: give good work; charge fair prices; be constantly on your toes for new business; don't hesitate to sell your customer what he needs. Be prompt and courteous and, by all means, keep your word. You can't fail, there is business, go and get it.

A STUDENT LOOKS AT THE SERVICE BUSINESS

Editor, RADIO-CRAFT:

I enclose a newspaper clipping, and call your attention to two of the classified advertisements under the heading "Radio and Equipment." They read as follows:

"50c per call—Expert service. Why pay more? — Radio Co."

"Amos says—Radio service calls 50c. Expert repairing. Phone —."

People will naturally see that and, when a real Service Man tries to charge about \$2.00 a call, he gets an earful; because they

say they can get the same for 50 cents.

I am an N. R. I. student, and want to make servicing my full-time work. But how the heck can a guy earn a living with people like this in the city? I suppose, because times are hard in this city, these two fellows couldn't get their regular job; so, just because they used to be hams in the old spark days, or used to take a radio magazine, they have to make life difficult for any good Service Man by charging four bits a call, just to get something to eat for the day.

I don't see why they picked on the radio service line for their pestering. Can't anything be done to make Service Men charge a reasonable price?

I have been a reader of your magazines for a long time, and was one of the first to subscribe for RADIO-CRAFT. I intend to build the portable radio testing laboratory described in the January and February issues because, believe me, I am going to be well informed and equipped before I start to service anyone's set.

LOUIS MINATEL,
2236 Roosevelt Avenue,
Indianapolis, Ind.

(There is at least one case, reported in an article written for RADIO-CRAFT by a successful Service Man, where the policy of offering a free preliminary examination of the receiver was successful in obtaining profitable business; but this does not seem to be indicated by an advertisement like the "Why pay more?" above. What is the experience of Service Men generally with competition of the kind indicated?—Editor.)

Servicing Brunswick Screen-Grid Models

(Continued from page 272)

If it is in the former, 0.5-mf. capacity can be used to replace it; if in the latter, the block can be replaced. This particular section is 1-mf.

Hum can usually be traced to a poor detector; interchange this tube with one of the other screen-grid tubes. A low-emission rectifier will also cause hum.

While the writer was with the New York distributor of Brunswicks, the majority of our calls were not, as expected, due to tube trouble but to slipping dials—which we will not discuss—and hum with a capital H. When the latter is not due to any of the

above causes, it can be remedied by connecting a condenser from the ground on chassis to the maroon lead going to the speaker field-tip jack. One microfarad will do the trick, 2-mf. will almost kill it and, if 3-mf. capacity is used the most exacting customer will be pleased (and tip you liberally?).

Very weak signals, with excessive voltage on screen-grids and all plates except the power tubes, indicate a shorted speaker field; and no voltages as above, with no signal, show an open field winding. See that these troubles are not external and due possibly to an open or short in the connecting plug shown in Fig. 2.

C1 is the 0.5-mf. tubular condenser in the R.F. end; C2, of the same value is located next to the "Ant." and "Gnd." posts on the R.F. end of the chassis; C3 and C4, the two tubular condensers between the second and third R.F. tubes and their respective coils, are each 0.1-mf.

C5, C6, C7, C8, C9, C10, C11, are respectively 1, 1, 1, 1, 0.275, 1 and 1 microfarad; they constitute the condenser block shown in Fig. 3.

SOUNDS LIKE CROSS-TALK

THE announcer at Kosice (Czechoslovakia) holds the record for the number of different languages used at the microphone. He speaks Serbian, Czech, Polish, Russian, Rumanian, Magyar, German and French!—*Amateur Wireless.*

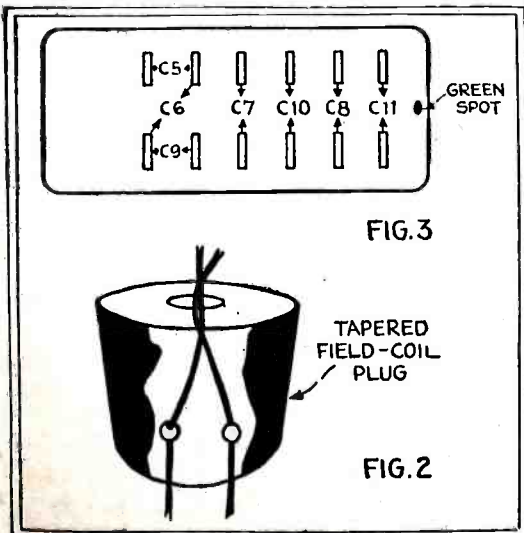

Look to the connecting plug of Fig. 2 when volume is weak, but tubes and voltages right. Above, condenser-block layout.

Makes Any Tube Last LONGER and Perform BETTER

By automatically keeping voltage exactly right for each tube, AMPERITE lengthens tube life and improves reception. *Never wears out.* Insist on AMPERITE. A type for every tube—A.C. or D.C. \$1.10 with mounting (in U. S. A.) At all dealers.

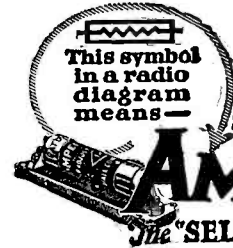

This symbol in a radio diagram means—

AMPERITE Corporation
661 BROADWAY, NEW YORK

FREE—"Amperite Vest Pocket Tube Chart." Write Dept. RC-11

AMPERITE
REG. U.S. PAT. OFF.
The "SELF-ADJUSTING" Rheostat

1931

FREE

RADIO CATALOG

LOWEST WHOLESALE PRICES!

Everyone interested in RADIO should have this Catalog. Solid with "Specials" from cover to cover. Teeming with values... every item a feature. All latest sets and equipment. Screen Grid, A.C., Humless, all electric sets... also battery operated sets and direct current sets. Dynamic speakers, beautiful consoles, kits and parts. Wholesale prices. Astounding savings. Get this FREE bargain book today

Chicago Salvage Stock Store
509 S. State St. Dept. 541, Chicago

WORLD-WIDE

SHORT WAVE RECEIVER

Span the World with this Set!

A new radio thrill for you! Listen in DIRECT to London, Paris, Berlin, Buenos Aires and other broadcasting stations throughout the world via short waves. Enjoy unique foreign programs from strange lands. Your ordinary receiver cannot tune in these low wave stations. WORLD-WIDE RECEIVER gets 14 to 550 meter stations with surprising clarity. **SEND NO MONEY!** Just write your name and address on a postcard and ask us to send you this wonderful guaranteed short wave set. Pay postman \$6.45 plus a small delivery charge. All orders West of the Rockies must be accompanied by \$1.00 deposit. Foreign countries must remit in full. Write today!

CHAS. HOODWIN CO.

4240 Lincoln Ave., Dept. L-150, CHICAGO

No Wind Can Blow It Out

SOMETHING DIFFERENT

Mystery Cigar Lighter

MAKE UP TO \$25 A DAY

Showing this Scientific Marvel to Men. New Principle of Ignition. What Makes It Light? No Flint or Friction. All Guaranteed. Sample with Sales Plan, 25c. Sample Gold, Silver or Chromium Plated, \$1.00. Agents. Write for Proposition.

NEW METHOD MFG. CO.
Desk SF-11, New Method Bldg., Bradford, Pa.

The Radiola "AR-812"

(Continued from page 273)

power stage, a "B" power unit, and a 6-volt storage battery. The changing of the first tube to a '12A is optional, but the improvement in volume and quality warrants it.

The internal circuit of the AR-812 within the catacomb is as Data Sheet No. 16, with the exception that V6 is a '20 output tube. The external connections to the bakelite connecting strip on the catacomb are somewhat different.

If we are to use a '12A as V1, it is better to change the sockets on the catacomb so that UX base tubes may be used; they are cheaper and easier to buy from local dealers. The addition of new sockets and the added height of tubes will force us to discard the old cabinet and build or adapt the chassis to a new one. If we stick to UV-'99's, and only add a power stage, the old cabinet may be retained.

First, disconnect the battery connections and loop from the catacomb, and remove the panel. Unsolder all connections to the jacks and switch, and remove all these connections from the set. Then take out and throw away the jacks and switch; for you will have no more occasion to use these obsolete articles. Remove the battery cable from the set; it may be ripped up later, to use the wire within it.

When the jacks are removed, connect lugs 13 and 14 on the bakelite strip of the catacomb.

The chassis may be lowered sufficiently to take X-'99 tubes by sawing off the aluminum legs of the catacomb, and placing the oscillator coil under the right condenser. It cannot, however, be lowered enough in this way to take a '12A tube.

To change to X-'99's and the '12A, take off the catacomb cover. Procure six Pilot No. 216 sockets, or others as small. Drill the proper holes in the cover to fit machine screws which will hold the sockets exactly over the old socket holes. Insert the screws and replace the cover. To the prongs of the old internal sockets, solder short pieces of wire, to be brought out later under and

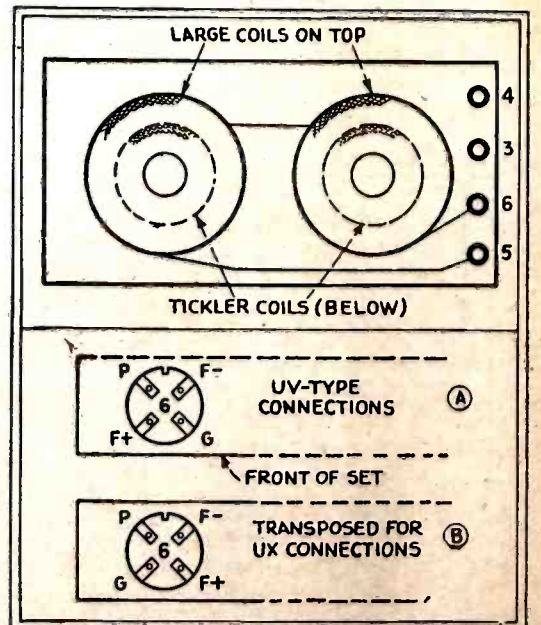

Fig. 4 (above) Fig. 5 (below)

Above, the connections to be made to the coils. Below, present tube connections at (A) and new connections for UX tubes at B.

George W. Walker FLEXI-UNIT

A Flexible Radio Device of Unlimited Application

- SHORT WAVE RECEIVER
- SHORT WAVE ADAPTER
- REGULAR BROADCAST TUNER
- R.F. PRE-AMPLIFIER (BOOSTER)
- RADIO "EXPERIMENTAL" UNIT
- OSCILLATOR WAVE TRAP

Use this unit ahead of your Short Wave Tuner as a R.F. Booster

Should your dealer be unable to serve you promptly — mail your order direct to factory.

List Price **\$16.00**
Including Coils

- No. '01—Adapter Plug (Battery).....\$2.00
- No. '27—Detector Plug (A.C. Sets)..... 2.50
- No. '27—R.F. Adapter Plug (A.C. Set).. 3.00

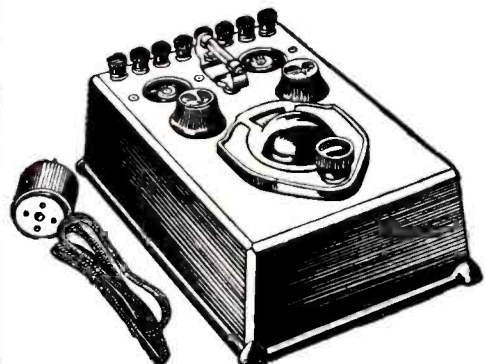

SHOWING No. '01 ADAPTER PLUG FLEXI-UNIT EXCLUSIVE FEATURES (Possessed By No Other Device on the Market)

- Efficient reception of the entire wave band of 15 to 550 meters with four silk insulated plug-in coils.
- An attractive Aluminum Cast Shield of one-eighth inch thickness to insure against body or hand capacity.
- Unit may be used with either A.C. or Battery receivers, or as an individual single tube receiver for short or long waves.
- Unique antenna connection arrangement insures freedom of oscillation at all frequencies without dead spots.
- Serves many purposes. Indestructible! Simple to operate — and inexpensive.

WRITE FOR FREE LITERATURE

One of America's Pioneer Radio Manufacturers

THE WORKRITE RADIO CORP. - 1808 E. 30th St., Cleveland, Ohio

Ten Tools In One

\$1.00

A small but handy article which serves for every possible need of the all-round mechanic. Invaluable in any emergency.

An excellent combination of utilities for the household — every necessity featured: hammer, knife-sharpener, nail-puller, bottle-opener, screw-driver, can-opener, cork-screw and weigh-scale. Just glance at the illustration and you will see how really useful this article is. Only 10 in. high. Indispensable to autoists, campers, Boy Scouts, canoeists, picknickers, etc.

Price \$1.00 Postage Paid. Be the first one in your town to own the "Ten Tools in One." Send coupon with your name, address, city and state with one dollar.

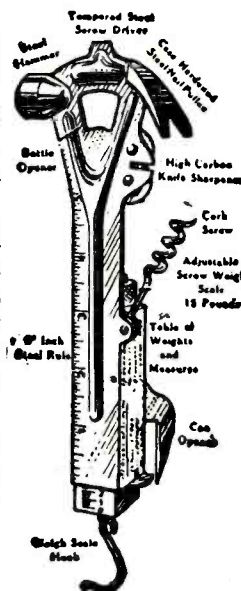

SEND FOR YOURS TODAY

MAIL COUPON

NOW!

Grenpark Company, 245 Greenwich Street, New York, N. Y. RC-11

Enclosed find \$1.00 for which please send me prepaid your "Ten Tools in One."

Name

Address

City..... State.....

CLASSIFIED ADVERTISEMENTS

DETECTIVES

DETECTIVES Earn Big Money. Excellent opportunity. Experience unnecessary. Particulars Free. Write, George Wagner, 2190B Broadway, N. Y.

INSTRUCTION

BE THE LICENSED RADIO DOCTOR of your community. Earn \$7.00-\$10.00 spare time evenings. Write now for free booklet, "Why the Radio Doctor?" Radio Doctors, Inc., Dept I, 131 Essex Street, Salem, Massachusetts.

INVENTIONS

INVENTIONS COMMERCIALIZED. Patented or unpatented. Write Adam Fisher Mfg. Co., 524 Enright, St. Louis, Missouri.

MISCELLANEOUS

BURIED TREASURE scientifically, accurately located by Radio. Sure money-maker for Radio Dealers. Details for Red Stamp. Exchange, Box 607, El Monte, California.

PRINTING

100 OF EACH, Business letterheads and Envelopes, printed, your copy \$1.50. CRANE, Box 7622 Kansas City, Missouri.

RADIO

SERVICE MEN, ATTENTION — Speakers re-wound, magnetized, repaired, \$2.00 to \$2.75. Complete Power Pack Service—Transformers re-wound, condenser blocks repaired, resistors duplicated. Guaranteed. Clark Brothers Radio Co., Albia, Iowa.

GET MORE DISTANT STATIONS—New frequency selector—guaranteed—\$1.00 postpaid. Noel, 1502 Pittston, Scranton, Penna.

up to the terminals of the new sockets. Don't forget to transpose the "F" and "G" leads as in Fig. 5. Now place the new sockets in position, bringing the leads out and soldering to the new terminals.

Do not solder to "F—" terminal of V1, which must receive an external 6-volt connection for the '12A. Final don't: do not screw down the sockets too tightly, or you'll break them.

Bore holes through the loop frame for the main "F—" lead; lug 9 will be unused when rewiring is completed. Bore two holes behind the output filter, for the speaker cords. Shunt the primary of the power audio transformer A.F.T. with a .006-mf. condenser; a variable volume control may also be used across these terminals, for better tone. This component should not have a higher ratio than 2½ to 1.

Place a "B" power unit in the old right-hand battery compartment; and a 40-volt "C" battery in the left compartment, for the '71A tube. If the power pack you have will not fit, you can take it out of its case, and rearrange the parts on a baseboard the width and length of the compartment. A 45-volt "B" battery which has been used a while will do for the new "C" battery. Of course the old 4½-volt battery may be discarded, and a tap taken from the big "C" battery.

The new filament and plate voltage wirings are shown in Fig. 3. Rheostats R1 (10 ohms) and R4 (20 ohms) are to be mounted on bakelite strips within the receiver and held to the side walls of the cabinet by brass angles over the condensers. Their adjustment is not critical and, once fixed, they need not be touched until the battery gets very low.

The addition of a battery trickle charger will completely electrify this set; it is advisable to use one which incorporates a relay. To adjust the voltage for the '99 tubes, use the full resistance of the rheostat R4 and set R2 half-way. Connect a voltmeter across the filament leads of any '99 tube, and advance R4 until the reading is just 3 volts. Only the best tubes should be used; inferior '99s may cause howling.

It is unwise to use an outside aerial longer than 15 feet.

"Midget" Radio Sets

(Continued from page 274)

The Newest Crosley

In the Crosley 54 ("New Buddy") a conventional circuit is used, with provision for a phonograph pickup (P1, P2). Resistor R1 is the volume control, and the reproducer (though in the diagram it seems like a dynamic) is a special magnetic unit, with an electromagnetic field replacing the more usual permanent magnets. (This circuit is the diagram of the latest "New Buddy" and hence it varies a little from previous releases dated July, 1930.)

As a matter of reference, the following values are given for the components:

Type '24 tubes are used at V1, V2, V3, and a type '45 tube for the power amplifier V4; V5 is an '80. Resistor R1 is a 25,000-ohm potentiometer; R2, 20,000 ohms; R3, 440 ohms; R4, 1 megohm; R5, 10,000 ohms; R6, 25 ohms on each side of the center tap; R7, 1650 ohms; R8, R9, R10, 10,000 ohms; R11, 150,000 ohms; R12, 1 megohm.

The condenser capacities are as follows:

PATENTS

INVENTORS

Write for these FREE BOOKS!

MY PATENT LAW OFFICES OPPOSITE U.S. PATENT OFFICE



At the left is a view of my drafting and specification offices where a large staff of experienced experts is in my constant employ. All drawings and specifications are prepared in my offices.

Protect Your Ideas

Take the First Step Today

If you have a useful, practical, novel idea for any new article or for an improvement on an old one, you should communicate with a competent Registered Patent Attorney AT ONCE. Every year thousands of applications for patents are filed in the U. S. Patent Office. Frequently two or more applications are made for the same or substantially the same idea (even though the inventors may live in different sections of the country and be entirely unknown to one another). In such a case, the burden of proof rests upon the last application filed. Delays of even a few days in filing the application sometimes mean the loss of a patent. So lose no time. Get in touch with me at once by mailing the coupon below.

Prompt, Careful, Efficient Service

This large, experienced organization devotes its entire time and attention to patent and trademark cases. Our offices are directly across the street from the U. S. Patent Office. We understand the technicalities of patent law. We know the rules and requirements of the Patent Office. We can proceed in the quickest, safest and best ways in preparing an application for a patent covering your idea. Our success has been built on the strength of careful, efficient, satisfactory service to inventors and trademark owners located in every state in the Union.

Strict Secrecy Preserved— Write Me in Confidence

All communications, sketches, drawings, etc., are held in strictest confidence in strong, steel, fire-proof files, which are accessible only to authorized members of my staff. Feel free to write me fully and frankly. It is probable that I can help you. Highest references. But FIRST—clip the coupon and get my free book. Do THAT right now.

No Charge for Information on How to Proceed

The booklet shown here contains valuable information relating to patent procedure that every inventor should have. And with it I will also send you my "Record of Invention" form, on which you can sketch your idea and establish its date before a witness. Such evidence may later prove valuable to you. Simply mail the coupon and I will send you the booklet and the "Record of Invention" form, together with detailed information on how to proceed and the costs involved. Do this NOW. No need to lose a minute's time. The coupon will bring you complete information entirely without charge or obligation.

Clarence A. O'Brien Registered Patent Attorney

Member of Bar of Supreme Court of the United States; Court of Appeals, District of Columbia; Supreme Court, District of Columbia; United States Court of Claims.
Practice confined exclusively to Patents, Trademarks, and Copyrights



CLARENCE A. O'BRIEN Registered Patent Attorney

3508 Security Savings and Comm'l Bank Bldg.,
Washington, D. C.

— OF —

Suite 1106, Dept. K-4, Woolworth Bldg., New
York City

Please send me your free book, "How to Obtain a Patent," and your "Record of Invention" form without any cost or obligation on my part.

Name

Address

(Important: Print or Write name clearly and address office nearest you)

**EVERY
SERVICE MAN
SHOULD OWN
THIS BOOK!**

**THE BIGGEST SELLER
IN
RADIO LITERATURE**



**S. GERNSBACK'S
RADIO
ENCYCLOPEDIA**

EDITED by SIDNEY GERNSBACK, Author of "Wireless Course in Twenty Lessons"—"One Thousand and One Formulas"—"Practical Electricity Course"—"The Radio Educator," etc.

S. GERNSBACK'S RADIO ENCYCLOPEDIA is the only standard work ever published in America attempting to classify alphabetically the countless words used in the highly specialized science of RADIO. The ENCYCLOPEDIA is written in plain English so that everybody can understand the definitions and descriptions.

No expense has been spared, covering over two years in compilation, to make it worthy a place in your library.

It is published in one volume—168 pages—size 9 x 12 inches, over an inch thick and nicely accommodates the beautiful illustrations and the large, easy-to-read type.

The work contains 1,930 definitions, 549 photographs, drawings and diagrams.

REMEMBER THIS IS A REAL ENCYCLOPEDIA — NOT A DICTIONARY — and very few of the things described and illustrated in this volume can be found in any dictionary, or any other encyclopedia.

The book contains as a supplement a classified cross index designed to bring together radio references under one heading, having relations in common.

All circuits new and old are described by word and picture and every part and apparatus used in Radio is explained and made understandable by means of photographs and drawings.

The volume is printed upon fine paper—bound in full black Keratol, marbled paper fly leaves and end sheets, with the title stamped in gold.

SEND NO MONEY

Just Pay Postman

(Canada or Foreign send Check or Money Order for \$2.35)

ISKOR PRESS, Inc., R-11-30
19 Park Place, New York, N. Y.

Send me one copy of Sidney Gernsback's First Radio Encyclopedia in one volume as advertised. I will pay postman \$2.00 plus postage on delivery.

Name

Address

Town and State

C4, C6, C7, C11, 0.1-mf., C5, C8, C12, 0.5-mf.; C9, C10, .00025-mf., C13, a "twin-8" electrolytic condenser.

(The pilot light, V6, is not used in the "Model 54" set.) The R.F. choke Ch1 and the condensers C9, C10, form a carefully-designed R.F. filter system. The receiver is illustrated at the upper right on page 274.

A Five-Tube Midget

The Jackson-Bell "Model 62" midget receiver embodies a special "constant-gain" R.F. circuit in which C5, C6, C7 play an important part. A feature is the "tone control" C13, R2. The power transformer is provided with an electrostatic shield, between primary and secondaries, which has the important purpose of suppressing the antenna effect of the A.C. line, with a consequent improvement in selectivity and complete volume control. A dynamic reproducer is part of the audio circuit design.

The following information is important for the Service Man called to work on one of these sets. The receiver may be resonated with or without an antenna, as the circuit of V1 is practically unaffected by the antenna constants. However, condensers C5, C6 and C7 affect the volume, selectivity, and sensitivity of the receiver. Balance the circuits at 20 and at 90 on the dial. If it is necessary to move any coupling condenser more than one-half turn in order to obtain resonance, adjustment of capacity in that particular stage should be made by bending the split rotor plate of the variable condenser (except the antenna stage where C1A does not affect coupling). After obtaining resonance at 20, shift to 90 and check circuits with a grid-dip meter. Here all capacity adjustments must be made by very carefully bending the section of the plates at this point. Too much coupling will result in instability at maximum volume adjustment. A good ground is necessary.

Condensers C11, C14, C15 are of the dry electrolytic type, and self-healing when immediately turned off after puncturing.

Incidentally, electrolytic filter condensers cannot be tested by the methods used in testing paper-dielectric condensers, because of the small amount of leakage current which is normal in these units. It is recommended, therefore, that they be tested with a D.C. potential of about 200 volts, using a milliammeter and a protective resistor. At this voltage the leakage current should not exceed one-tenth of a milliamperere per microfarad after five minutes. (If the condenser under test has not been in use for some time, the leakage current may run as high as one milliamperere per microfarad at 200 volts when the test voltage is applied. This will gradually taper off to approximately 1/10-ma. per microfarad within five minutes, if the condenser is in good condition.)

Following are the values used in this set: Volume-control resistor R1, 3,000 ohms; R2, 10,000 ohms; R3, 250 ohms; R4, 30,000 ohms; R5, 0.5-megohms; R6, 2 megohms; R7, R8, R9, 10,000 ohms; R10, 5,000 ohms; R11, 2,200 ohms; R12, 30,000 ohms.

Condensers C5, C6, C7, 7 mmf.; C8, C16, C17, C18, 0.1-mf.; C9, C19, 1.0 mf.; C10, .00025-mf.; C11, 8 mf.; C12, .02-mf.; C13, .25-mf.; C14, 2 mf.; C15, 4 mf.

The "Simplex"

The Simplex "Model H" midget set at the upper left uses two stages of screen-grid R.F. amplification, a screen-grid detector, and a type '45 power tube in a circuit very similar to the Crosley "New Buddy." However, an additional feature is the use of the light-line as an antenna, when convenient, the R.F. signal passing through a .001-mf. condenser. There is a tone control in this receiver.

Screen-Grid Super

(Continued from page 276)

After determining that the primary of the transformer must be tuned, there is still left one remaining option; tuning both the primary and secondary, or the former only. Tuning the secondary, of course, would eliminate the short-circuiting effect of the input capacity of the tube.

But, when both the primary and secondary are tuned, a maximum transfer of energy no longer takes place with close coupling. The condition for maximum transfer of energy is, to the contrary, very loose coupling. Since space limitations prohibit separating the primary and secondary by a space of six or more inches (depending upon the type of coil used), it was found necessary to run one of the coils so that it was practically at right angles to the other. Unfortunately, there is no such thing as perfect shielding.

The tuned primary transformer, however, gave a gain of 75 per stage, at a frequency of 475 kilocycles with complete aluminum shielding and by-passing; or more than can be successfully used.

The complete details of the latest model of the latest Lincoln receiver, Model "De Luxe 31," illustrated herewith, show the application of this coupling system to a receiver chassis which has been laboratory-built and tested. Four intermediate-frequency screen-grid stages in cascade are coupled into a screen-grid second detector; the solenoids used as transformers have their primaries tuned by low-loss variable condensers of the stator-rotor type. The successful control of the five tuned plate circuits produces a selectivity whose graph-curve is of the "straight hair-pin" shape, indispensable for high quality reproduction accompanied by the keen selectivity needed in presence of local broadcast stations. A distant station is thus often brought in with full volume without background; while a slight movement of the dial is sufficient to show the presence of a local only ten kilocycles away.

The mechanical details of this chassis may be seen from the photographs reproduced here; it has a heavy cadmium-plated steel base, on which the components are solidly mounted, and a compact power unit separately mounted. The set chassis is 10 $\frac{3}{4}$ x 21 inches, the panel 7 $\frac{1}{2}$ x 10, affording the customer the widest choice of consoles; the power unit is 9 $\frac{1}{2}$ inches square by 7 high. Their weights, packed, are approximately 21 and 25 pounds.

The tube equipment required includes two '27s for oscillator and first audio; six '24s for the two detectors and the four intermediate-frequency amplifiers; two '45s in the

output, and an '80 rectifier. The chassis is wired to receive the leads of a phonograph pick-up, to which it gives a stage of screen-grid amplification as well as the normal two stages of audio.

GANGED RESISTOR UNITS

FOR the sake of convenience in mounting and wiring, several prominent set manufacturers are ganging their metallized resistor units, by arranging them side by side in a row and strapping them together at their center with one straight strip beneath and a corrugated strip on top, with screws through holes at the ends of the strips. This method is possible only with resistors having an insulated body rather than a conducting body. Connections are readily made to the ends of the resistors, which are fully exposed and free for the purpose.

The ganging of metallized resistors makes for a compact, simple, readily-serviced receiver; since all resistors are concentrated in one place where they may be readily checked up and replaced if necessary.

TROUBLE-SHOOTERS' RECORDS

TO assist listeners in identifying different kinds of local noises and static, a Czechoslovakian firm has produced a phonograph record in which every known form of interference is included from natural atmospheric to the noises created by household appliances. It is said that listeners and radio clubs are highly enthusiastic over this idea and that a wide circulation has been gained for the records.

Times Square Studio

(Continued from page 279)

A somewhat similar problem in estimating the proper balance between announcements and the other parts of the program to produce a pleasing combination, necessitated the practice of keeping the volume of the announcements six decibels* below the program level. This is a policy followed in all N. B. C. studio operating practices.

(This studio, at last reports, is being fitted also with television pickups for broadcast tests.—*Editor.*)

* The *decibel* is a unit devised by telephone engineers to measure increase or decrease, either in the volume of a sound, or in the power of the A.F. electric current which is used to produce a sound (the word is derived from the name of Alexander Graham Bell, inventor of the telephone). Because the human ear has not a "straight-line characteristic," the decibel must be measured, not on a straight scale, like volts or amperes, but on a logarithmic scale. This is another way of saying that the ear judges the amount of change in the loudness of a sound, not by the actual value of the pressure upon it, but in proportion to the degree of loudness to which it has last accommodated itself. A small "absolute" change in the volume of a weak sound gives just as distinct an effect as a very great "absolute" change in the power creating a very loud noise. The noticeable change in the "volume" of a sound, or power output, is one amounting to about 25% up or 20% down from the previous value. This ratio is one "decibel"; also known as a "transmission unit," because it was originally devised to measure the loss of audible signal strength in transmission through standard telephone cable. The number of decibels by which the volume of sound, or wattage of A.F. current, is varied is numerically equal to ten times the "common logarithm" ("to base 10") of the ratio of the change—or twenty times the logarithm of the ratio of change in either voltage or current.



**See for Yourself
Why TRUVOLTS
are BETTER**

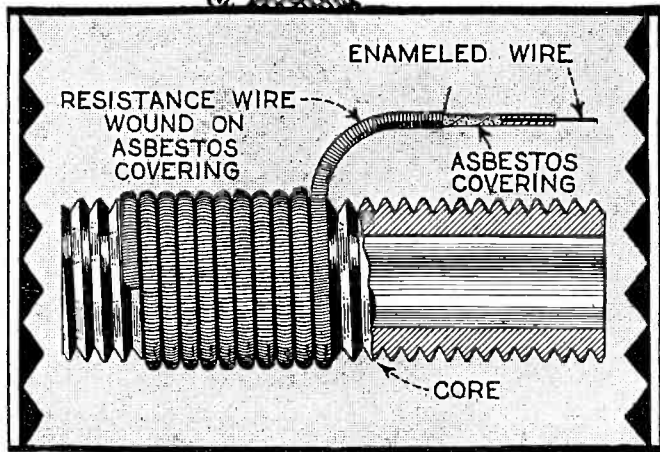

**For
Eliminators
and
Power Packs**

U. S. Pat. 1676869
and Pats. Pend.

TRUVOLT RESISTORS are "double wound." The resistance wire is first wound around an asbestos covered enameled copper core. This is then wound around a grooved fire-clay base. Only with this distinctive winding, patented by Electrad, can there be secured the greater air-cooling which has made TRUVOLT world-famous as the Perfect Performing Resistor.

TRUVOLT Resistors have long been the first choice of radio service men for replacement purposes because their experience proves that only the best is good enough. The open air-cooled winding (see illustration) insures lower operating temperature, more accurate values and longer life in battery eliminators and power packs. All TRUVOLT Models (of the type pictured above) have a convenient sliding clip for exact adjustment of resistance value. This feature, found only on Electrad TRUVOLT Resistors, greatly simplifies service installation and experimental work. It also cuts down the number of replacement units necessary in the service kit.

Made in all usual sizes and wattage ratings. Also TRUVOLT Resistance Banks for different circuits.

ELECTRAD manufactures a complete line of resistors and voltage controls for every radio and power supply requirement, including TELEVISION.

Intelligently standardized production and mass purchasing of raw materials effect large savings in Electrad's original manufacturing costs—savings which are passed on to consumers in Electrad's moderate prices for exceptionally high-grade products.

175 Varick St., New York, N.Y.
ELECTRAD
INC.

**Super-TONATROL
Heavy Duty
Volume Control**

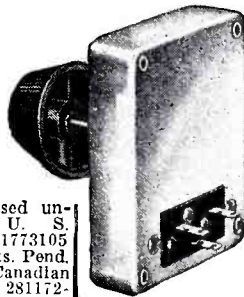

Licensed under U. S. Pat. 1773105 & Pats. Pend. and Canadian Pats. 281172-286778

Built for long life with heavy currents. Resistance element PERMANENTLY fused to enameled metal plate. Easily dissipates 5 watts. Pure silver multiple contact provides smooth operation with stepless variation. Metal cover, riveted for strength. 7 types to meet most volume control needs. \$2.40 to \$3.50.

MAIL COUPON FOR ELECTRAD DATA
ELECTRAD, INC., Dept. R.C.-11, 175 Varick Street, New York, N. Y.
Please send circuit diagrams describing TRUVOLT RESISTORS and Super-TONATROL.
 Check here for literature on complete Electrad Line.
Name.....
Address.....

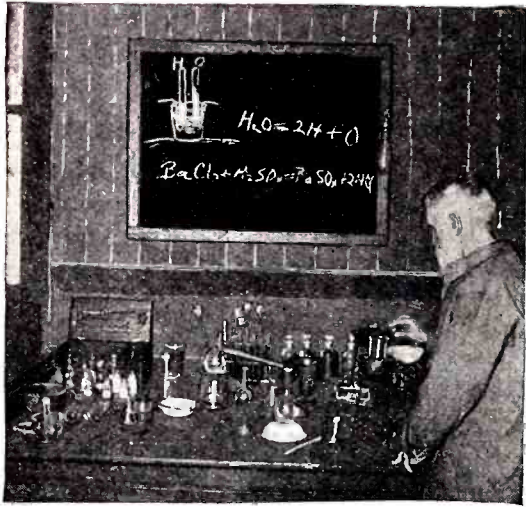

Dr. T. O'CONOR SLOANE Will Teach You at Home!

ANYONE WHO CAN READ AND WRITE can study Chemistry through our simply prepared course. You don't need a higher education, and you don't need any previous experience or preparation. Chemistry is not harder to understand than electricity or radio. Just plain sense and ordinary observation powers.

Laboratory Outfit Free

THE COMPLETE CHEMICAL OUTFIT and APPARATUS supplied to you as part of your Course, without extra charge, makes you the owner of a laboratory, containing all the materials and instruments used by a full-fledged chemist. This working kit, which is shipped to you at the outset of the course, becomes your permanent property. It is a sturdy fitted wooden cabinet containing over 100 pieces of laboratory apparatus and chemical supplies.

We Can Teach You At Home

Our faculty knows just how to mold you into a skillful laboratory worker. THE HEAD OF OUR STAFF IS DR. T. O'CONOR SLOANE, scientist, engineer and author of wide repute. He has had more than fifty years of teaching experience. Our course fits you for an immediate position in a chemical laboratory, and you do not have to give up what you are doing now to learn it. During evenings and week-ends you can work at home on the fascinating experiments and the delightfully simple but comprehensive lessons.

Big Money in Chemistry

CHEMISTS ARE WELL PAID MEN. Not only will our training help you to get a better job, but a worthwhile start on a new level. You can patent the work of your hands and your brain, and perhaps make millions of dollars on a new chemical discovery. Every day the newspapers and magazines are full of new items reporting new chemical discoveries—in mining, in electricity, in foodstuffs, in sanitary and medicinal appliances, in paper-making, rubber, steel, iron, dyestuffs, textiles, in fact in every well known industry—and behind each of these discoveries stands a well-trained chemist who knew how to take advantage of opportunity!

No Exaggerated Claims

THE INSTITUTE DOES NOT CLAIM that every chemist makes millions, nor do we guarantee that you will immediately get a job paying \$10,000 a year. But many have done it and there is no reason why you can not do it too. Often enough you read or hear about men who have found the highest recognition, from small, inconspicuous beginnings, and you wonder how they got the "lucky break." Why, you wonder yearningly, couldn't you be such a "lucky" fellow? You can be—but you have to meet luck half way.

Get Started Today!

IF YOU WOULD LIKE TO KNOW MORE ABOUT CHEMISTRY, and if you are sincere in your desire to get out of the tread-mill of job anxiety and wage dependence, if you have ambition enough to want to become a chemist, and perhaps a famous one some day, you will not wait until tomorrow to find out how to go about it. MAIL the coupon below today. There is no charge and no further obligation. You will be simply asking us to write you about something that you want to know.

Chemical Institute of New York, Inc.
Dept RC-1130
19 Park Place, New York, N. Y.

Please send me at once, without any obligation on my part, your Free Book "Opportunities for Chemists," and full particulars about the Experimental Equipment given to every student.

NAME

ADDRESS

CITY..... STATE.....

A New Self-Contained Television Reproducer

(Continued from page 277)

image is traced. The time relations of the impulses are so synchronized that a systematic scanning of the image, by the bright, glowing point, is effected. The television impulses, which have been superimposed on the cathode current, modulate the brightness of the scanning point and thus reproduce the shades of light and darkness in the image.

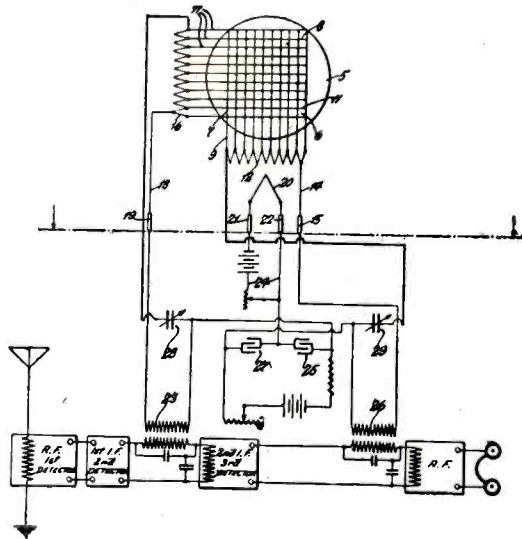

Fig. 3 (above)
The circuit of a television receiver using the Wald tube.

Fig. 1
An end view of the tube, showing the cross wires which tap the secondaries.

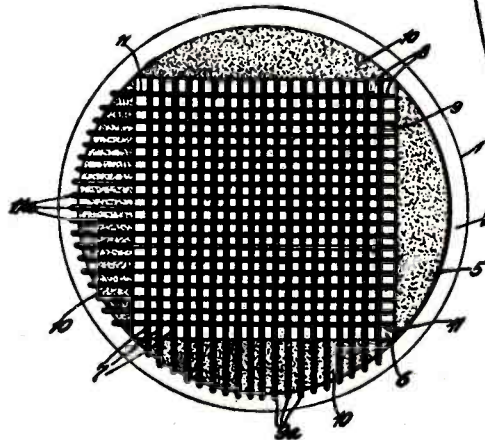

Fig. 2 (right)
A cross-section of the new tube, showing the relative positions of its elements.

The tube shown in Fig. 2 is of a modified type, such that the portions of the secondaries to which the taps are connected are placed inside the envelope. It has six prongs, the connections of four being shown. There are two more, connected to the anode and cathode tuning condensers which are shown at 28 and 29 in Fig. 3. These condensers serve to adjust and center the image on the frame. A slight change in the tube will permit it to receive the image from any station, even though the latter does not use the variable-frequency system described below.

The Transmitting System

The transmitting apparatus invented by the writer works on a similar principle; it contains the light-sensitive elements, similarly arranged in two systems of lines crossing at right angles. The television impulses, as amplified, are superimposed on two varying-frequency currents, corresponding to the scanning. The image-frequency is separated from these, and the television current is broadcast together with an actuating carrier wave.

For telephonovision, the voice is transmitted on the same wave as the image, by using a part of each image-line to record sounds. At the transmitter, the voice is

converted into light and applied, at the end of each image line, to the same photoelectric cell that transmits the image. At the receiver, that part of the image line is reconverted into a voice current in the conventional manner.

The writer is at present developing an invention which will reduce the dot-frequency required in television (usually regarded as the square of the number of lines in the image multiplied by the frequency of scanning) to about the square-root of the present frequency value. This, by reducing the high modulating frequency and consequently the width of the transmitting channel, will overcome one of the greatest obstacles to the development of television. The system, however, is still in process of perfection.

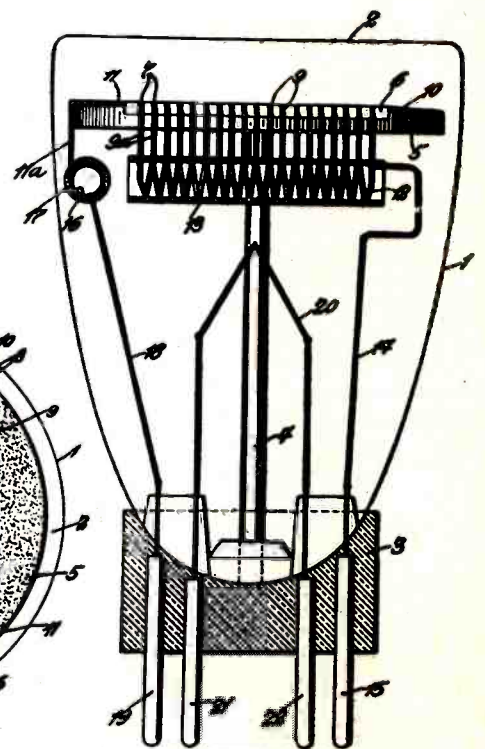

BRITISH TELEVISION WORK

STAGE effects in television, as shown by the experiments of the General Electric laboratories a couple of years ago, present novel problems; since the photoelectric cell does not see as the eye does. Because of the limited size of the image, when the first television play, "The Queen's Messenger," was produced at Schenectady, faces and hands could not be shown together; and one pair of actors presented the former, and another played the latter features.

The British Broadcasting Co., which is semi-governmental, is now carrying on television work on the regular broadcast band, from Brookmans Park station near London; and on July 14 it staged Pirandello's "The Man with a Flower in His Mouth." For this, an account stated, "scenery" was used. The scenes were painted in bold black on white boards, about three feet by two; and it was not considered practicable to show the actor and the background at once. The looker-in, therefore, had to commit the scene to memory while watching the actor. The British transmissions, it will be noted, are but 30-line images, instead of the 48- to 72-line transmissions available here on the shorter waves only.

Changes of scene were effected, not with a mixing panel of the type used in the American television play, which blended the electrical impulses in a fade-over; but by the simple method of raising and lowering a blackboard which served as a curtain.

Experiments with blue-and-white, green-and-black, and yellow-and-red facial make-ups for the actors finally brought out the fact that white faces, with contrasting lines blackened, give the best results. The work described, of course, represents only a beginning in television technique. The public interest is thus being allowed to grow up with the progress of the art of television in England; contrasting with the policy in the United States, where it has been decided to keep general broadcast listeners "in the dark" until the development of television to a commercial basis shall force its recognition.

New Applications

(Continued from page 280)

grid will always attract a layer of negative electrons to the inside of the glass, on which there is therefore an effective negative charge. If, on the other hand, a negative voltage is put on the film of metal, it attracts all the positive ions of gas inside the tube. There are few of these in the high-vacuum tube, but a comparatively large number in the gassy tube. The peculiar effect of these reversed control voltages is indicated in Fig. 2.

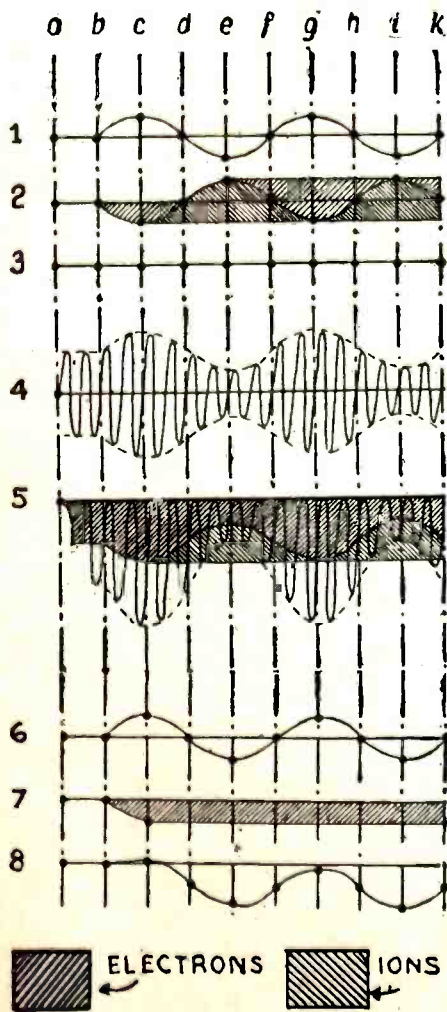
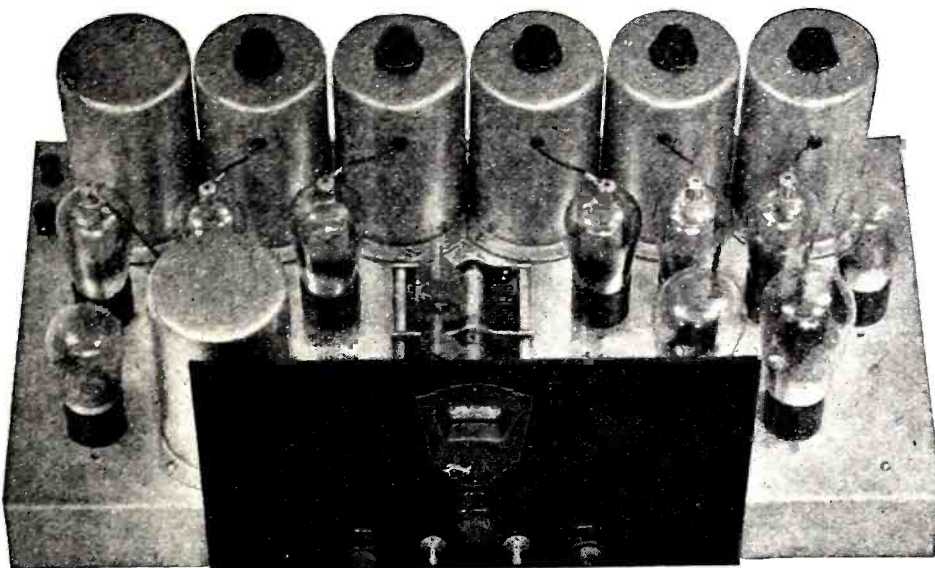

Fig. 2

The voltage effects in the detector "Arcotron" at audio frequencies (1, 2, 3) and radio frequencies (4, 5) are explained on page 308. The high-vacuum Arcotron gives (6, 7, 8) a fluctuating negative bias.

Actual Verified Performance



New Standards Again Set by the Lincoln De Luxe 31

SELECTED by men of international fame who want the best.
 APPROVED by prominent Engineering Colleges.
 VERIFIED by unbiased laboratory reports.

Lincoln Engineering has never produced any sensational discoveries, but has conservatively offered to the discriminating buyer radio performance which has been made possible by years of research work. AND NOW comes the new De Luxe "31" with all of the proved superior qualities of the De Luxe "10" with added features: High grade cadmium plated steel chassis; Six screen grid tubes with high gain perfectly controlled; Completely shielded antenna and oscillator coils; Phonograph attachment utilizing the finest audio system known; Local and long distance switch; Absolutely no A.C. hum.

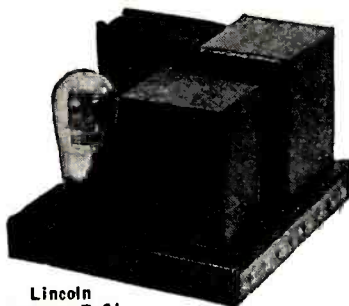

Lincoln De Luxe B-31

Think of 312 verified stations logged on the De Luxe in Brooklyn, N. Y. This exceptional performance has been published repeatedly in New York papers by enthusiastic owner. DISTRIBUTION: Made only thru qualified distributors. Many of our distributors are making from \$200.00 to \$400.00 a week. When you sell the De Luxe "31" you not only are selling verified performance, but you are getting the co-operation of everyone in our nine-year-old Corporation, who, together with hundreds of our good friends and authorized distributors, have put Lincoln equipment into many of America's most prominent and wealthy homes. If you are qualified to handle and service this equipment, write for full information and special demonstrator discounts.

Lincoln Radio Corporation

DEPT. RC 329 S. WOOD STREET CHICAGO

Newest THING IN RADIO

Vari-Tone

MAKES A 1931 MODEL OF YOUR PRESENT RADIO

\$2.95

Gives you TONE CONTROL!
 Connects in One Minute to any Electric or Battery Radio

TRY IT A WEEK At Our Risk!

Makes your set sound like a latest 1931 "tone control" model. **SATISFACTION or money back!** Vary tone and pitch to suit yourself. No need to buy a new \$200 radio. Send \$2.95 or order C. O. D. Free literature. Radio agents wanted.

VARI-TONE LAB. Dept. 895
 P. O. Box 700, Cincinnati, O.

1 and 2-Watts Cartridge Type

Standardize on

LYNCH METALLIZED RESISTORS

New low prices—new liberal discounts. More value for less money. Greater safety factors. Accuracy in construction and ratings. Give your customer the BEST at less cost. **GUARANTEED.**

JOBBERS - DEALERS - SERVICE MEN

Send for new illustrated, descriptive catalog "C."

LYNCH MFG. CO., Inc.
 1775 Broadway, N. Y. C.

Precision Wire Wound

FREE



Magazine Covers of Beauty for Practical Service

Read in comfort with your magazine held in the firm grip of this handsome cover. It is restful as a reading stand and much more convenient to use.

Its beauty adds to the neatness and attractiveness of your reception room or office. No longer will your copy of RADIO-CRAFT present a tattered or torn appearance if protected by this handsome and sturdy cover. Available in colors of Red, Green, Blue, Brown and black. Title embossed in gold.

This attractive cover will be sent to each subscriber who sends in his subscription to RADIO-CRAFT for one year at the rate of \$2.50.

RADIO-CRAFT

98 Park Place

New York, N. Y.

Become a Reporter!



Thousands of opportunities for young men to enter the Newspaper field. Fascinating work. You will meet interesting people; interview celebrities. A famous New York reporter with twenty years of practical experience has written a whole course of journalism and reporting in six easy lessons. He shows you the short-cut to success. He tells you what to do and what not to do, to become a successful reporter. Send today for the "PRACTICAL COURSE IN JOURNALISM," by Henry John Brockmeyer of *The New York Evening Post*. Just drop us a Postal Card—no need to send money. We will mail you the whole set of six books and you pay the Postman \$3.00 plus a few cents for postage. No more to pay. Money absolutely refunded if not satisfied.

PRESS GUILD

16-E Murray Street Dept. D-1030 New York

DO YOU WANT TO STOP TOBACCO?

Banish the craving for tobacco as thousands have. Make yourself free and happy with Tobacco Redeemer. Not a substitute, not habit forming. Write for free booklet telling of injurious effect of tobacco and dependable, easy way to relieve the craving many men have.

FREE BOOK

Newell Pharmacal Co.
Dept. 928 Clayton, Mo.

SELL "THE BEATS ALL" CHRISTMAS CARD BOX ASSORTMENT

Biggest value ever offered; 21 large cards and folders. Tissue lined envelopes. A \$2.20 value; costs you 50c. postpaid. Fastest \$1.00 seller; sample portfolio furnished. Write quick.

NUMETHOD CO., Desk SFC-11, Numethod Bldg., Bradford, Penna.

PATENTS Write for Free Guide Book, "HOW TO OBTAIN A PATENT" and Record of Invention Blank. Send model or sketch and description of your invention for our Free Opinion whether it comes within Patent Office Rules. RADIO and ELECTRICAL Cases a Specialty. Prompt, Efficient Service. PAYMENT OF FEES IN INSTALLMENTS

VICTOR J. EVANS & CO., 923 - 9th, Washington, D. C.

In the "Arcotron" of the gassy type, when the grid is negative, positive ions pile up on the glass; and, when the grid is positive, electrons take their place. As a result, if a low- or audio-frequency voltage is applied to the external grid of this tube, as at (1) in Fig. 2, during the first quarter-cycle *b-c* electrons are drawn up against the glass the charge on which is represented at (2). As the grid becomes less positive, from *c* to *d*, while it loses electrons, the positively-charged gaseous ions put in their appearance; and, when the outer grid is at its greatest negative voltage *e*, the glass is crowded with them. The result is that the combined action of the applied signal voltage and of the tube's own moving charges produces the zero field (3) between filament and plate. This tube therefore is quite unsuited for A.F. amplification; because the grid has no control over the plate current, as shown at (3). On the other hand, if it is operated at radio frequencies (4), the slower-moving ions are unable to keep pace with the electrons, and the glass is not instantly loaded with ions at the beginning of a negative cycle. The result of this unsymmetrical response to the two halves of a cycle (as at 5) is to make possible R.F. amplification with this tube. At 50 cycles, the voltage change on the plate amounts to only 1/100 that on the grid; it is only at about 10,000 cycles that the tube begins to amplify. This peculiarity makes it possible to heat the filament directly with alternating current; an impossibility in other detectors. This tube is the "Type 301."

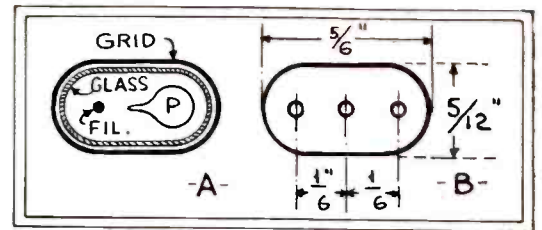

Fig. 1

Left, a horizontal section through the elements of the "Arcotron." Right, the dimensions of the base.

The A.F. or high-vacuum tube is known as the "201"; it, on the contrary, contains so little occluded gas that the influence of the ions in producing distortion is practically negligible. The effective input voltage (8) is practically the same as the applied voltage (6), because the attracted electrons produce a continual negative bias.

Because of these peculiarities of the two tubes, it is practically impossible to present for them characteristic curves such as are familiar for older types; though they are said to be quite stable in their operation. They operate on a filament voltage of 1, at which they draw only 1/4-ampere each.

The circuit of an electric receiver using two of these tubes, with an audio output tube of a standard type and a rectifier, is given in Fig. 3. The direct coupling between the plate of the first "Arcotron" and the grid of the second will be at once observed; as well as the tapping of the transformer secondary for two filament voltages. Values do not accompany this diagram.

Whys and Hows of the Short-Wave Super

(Continued from page 283)

its selectivity; but, without the loop, and protected only by one tuned circuit, it must accept anything impressed on its first detector—and a single tuned circuit is astonishingly broad in its tuning. I have seen broadcast-frequency superheterodynes which showed six tuning points for one nearby powerful station.

Additional I.F. Stages

While the short-wave super is most economical when it comprises only two I.F. stages worked at their maximum output, additional convenience and flexibility are obtainable.

As stated in the previous issue of RADIO-CRAFT, a set using two stages of I.F. can be conveniently simplified and controlled by employing a switch to throw the second detector into and out of oscillation, for the reception of C.W., or I.C.W. However, by varying the regeneration, maximum sensitivity and hence amplification of weak signals is made available for the chap who wants "DX."

With this combination, the operator would find that every adjustment of the volume control (which varies the voltage on the screen-grids of the I.F. amplifiers) calls for another adjustment of the regeneration control. This "interlocking" is inevitable with all such I.F. amplifiers followed directly by a regenerative detector, because the plate coil L1 of the I.F. amplifier V1 is the grid (See Fig. 1). Consequently, the high re-

generative voltage effective on the detector grid is also facing the plate of the screen-grid tube, and is impressed across the small plate-to-grid feed-back capacity of the tube. The first result is the interlocking of volume and regeneration control; and the second, the increasing of the screen-grid tube to a highly regenerative and hence somewhat noisy state.

The Blocking Tube

Overcoming this trouble is relatively simple. It is done by using what is termed a "blocking tube," the purpose of which in this circuit is only to isolate the I.F. amplifier tubes from the regenerative detector circuit and thus prevent the regenerative interlocking of regeneration and volume controls. A desirable by-product is less noisy reception.

This blocking tube is merely another screen-grid tube (V2 in Fig. 2) so used that the full R.F. voltage across the detector plate coil is not effective also across the plate-grid capacity of V2. A high-ratio (say 1 to 14) R.F. transformer couples the two tubes. Conversely, looking at it from the detector, this transformer L2 of course steps down instead of stepping up; hence a lower A.C. potential exists between the plate of V2 and ground than between the grid of the detector V3 and ground. The result is, of course, that this blocking tube is not doing much amplifying. Yet, if it did nothing more than divorce the regeneration control from the volume control, it would serve its purpose. However, even

with such an unusual ratio as that suggested, V2 can and does add noticeably to the overall I.F. amplification while serving its blocking function admirably. The result is a smooth and independent regeneration control which may be set as finely as desired. And, of course, the added tuned circuit for the third I.F. tube V2 has the advantage of increasing selectivity in the intermediate amplifier. (To be continued)

The Car Battery

(Continued from page 285)

be a rugged instrument to withstand the shocks of operation. It contains an iron vane suspended in the fields of a permanent magnet and of a coil of two or three turns through which the current flowing through the ammeter passes. The resultant of the two fields determines the position of the vane and, consequently, the reading of the ammeter.

It is desirable to bear in mind that the storage battery is of very low internal resistance. When fully charged, and shorted, it will deliver 150 to 200 amperes.

Operation During Charging

The electrical connections have been shown in Fig. 1; the armature of the generator is coupled mechanically to the car motor, so that it revolves whenever the engine is running. The residual magnetism of the generator's field poles causes a voltage across the main brushes whenever the armature is revolving. The generator is a shunt-field machine, whose third brush is a means of tapping the generated voltage to obtain the proper field current. It will be seen that, because of this manner of exciting the field, the field and the armature form a series circuit. The current flowing in the field creates magnetic flux which aids the residual magnetism, and thus causes the generated E.M.F. to increase further until it reaches a value of 12 to 14 volts when, as said above, the shunt winding of the magnetic relay creates sufficient pull to operate the relay. When this occurs, the generator sends a charging current into the storage battery, opposing its own voltage. The current which flows through the series winding of the reverse-current relay weakens the magnetic flux acting on the relay arm, because it sets up flux opposing that of the shunt winding.

Since all electrical circuits contain resistance, the voltage drops are equal to the voltage increases in any complete circuit. The generator's resistance is approximately one-third of an ohm, and that of the battery from a fiftieth to a tenth of an ohm, depending on its state of charge.

If we neglect the resistances of the other parts of the circuit (which are small in comparison with those of the battery and the generator when the connections and joints are clean and tight) the largest voltage drop occurs in the generator. From this it follows that the major part of the power loss is caused by dissipation within the generator. However, if high-resistance joints are caused by corroded or loose connections, the voltage drops in them will decrease the charging rate of the battery.

(Continued on page 310)

NOW FIX ANY MAKE OF AUTO



SIX BIG AUTO BOOKS ALL SHIPPED FREE

on approval; whether you want to qualify as garage owner, auto repair expert or merely wish to know how to keep your own car 100% efficient, look at these books—they are sent to you for free examination. This brand new 1930 edition has been prepared by a large group of America's greatest automotive engineers. Anybody who can read will understand them, for this great automobile encyclopedia is a veritable gold mine of valuable facts. Take advantage of this great opportunity now; send in the coupon for FREE examination. You don't pay us a penny, you don't obligate yourself to pay anything unless you decide to keep the books. Just tell us you want to see them and the full set of 6 great volumes, just off the press, will be sent to you. Read them, look them over and prove to your own satisfaction that one fact alone, which you will find in them, may save you an expensive repair, or help you to a better job.

AVIATION MOTORS
In addition to being a complete encyclopedia of automobile engineering these books contain over 1400 pages on Aviation Motors, and as they are just off the press they bring to you the newest and latest information obtainable. This alone makes these books invaluable to anyone.

NEW 1930 EDITION EVERY PAGE UP TO DATE

Imagine books which are so new that with the co-operation of the largest automobile manufacturers we have been able to bring every page right up to date—wiring diagrams, construction details, service problems—are all right up to the minute. Nowhere else that we know of can you get as complete and up to date information. Over a million dollars of resources have enabled us to give you the most up to date books on the subject ever published. You will find nearly 20 pages on front wheel drives alone. Everybody interested in automobiles in any way will welcome these books, especially on our

NO MONEY OFFER

This plan brings this valuable information within the reach of everyone. You don't send us a single penny; you don't have to pay us anything; just send your name and address and we will send you the complete set of 6 volumes specially bound in De Luxe Flexo covers. Read them carefully, keep them 10 days, find out anything you want to know and then if you want to keep them send \$2.00 then and \$3.00 per month until the special low price of only \$24.80 is paid. There is no further obligation.

Jiffy Index

You don't have to read the books through, the special Jiffy Index enables you to put your finger on the information wanted in a jiffy.

American Technical Society Membership FREE

If you send now for this brand new 6 volume edition of automobile engineering we will include a consultation membership in this great organization. Our large staff of automobile and aviation experts will be ready to help you at all times—you can write or wire any time for special information—answers will be sent to you promptly WITHOUT COST. This membership is good for one full year.

Learn All About Autos

Get these 6 big new books on this liberal offer and learn all the things you want to know—carburetors, transmissions, springs and spring suspensions, brakes, four-wheel drives, front-wheel drives, lubrication systems as well as over 100 pages on Aviation Motors—all of these subjects are fully covered. These complete and comprehensive auto books are yours, if you want them, on this easy plan. Send for your set now.

SEND NO MONEY

American Technical Society, Dept. Drexel Ave. at 58th St., Chicago, Illinois

I would like to see the new 6 volume 1930 edition of your automobile books but without any obligation to buy. I will pay the few cents delivery charge only and will examine the books and return them at your expense in 10 days unless I like them, in which case I will send you \$2.00 then and only \$3.00 per month until the special price of only \$24.80 is paid. You are to include free consulting membership certificate in the American Technical Society. Send brand new 1930 edition.

Name.....
Street.....
City..... State.....
Employer's Name.....
Employer's Address.....

These books will be sent free immediately upon receipt of coupon with writer's name and address and that of his employer or other business man as a reference.

If you have not already mailed your membership card to the NATIONAL LIST OF RADIO SERVICE MEN, be sure to do so today. Clip the coupon from page 262 and mail it promptly.

QUIT TOBACCO

No man or woman can escape the harmful effects of tobacco. Don't try to banish unaided the hold tobacco has upon you. Join the thousands of inveterate tobacco users that have found it easy to quit with the aid of the Keeley Treatment.

KEELEY Treatment For Tobacco Habit Successful For Over 50 Years

Quickly banishes all craving for tobacco. Write today for Free Book telling how to quickly free yourself from the tobacco habit and our Money Back Guarantee.

THE KEELEY INSTITUTE
Dept. L-707 Dwight, Illinois

PATENTS TRADE-MARKS

DO NOT LOSE YOUR RIGHTS TO PATENT PROTECTION

Before disclosing your invention to anyone send for blank form "EVIDENCE OF CONCEPTION" to be signed and witnessed.

LANCASTER, ALLWINE & ROMMEL
(Registered Patent Attorneys)
475 Ourray Bldg., Washington, D. C.
Originators of forms "Evidence of Conception"

TRUSS USERS

STUART'S ADHESIF PLAPAO-PADS are patentably different—being mechanico-chemico applicators—made self-adhesive purposely to keep the muscletonic called "PLAPAO" continuously applied to the affected parts, and to minimize danger of slipping and painful friction. The fabric is soft as velvet, and being adhesive—

—clings closely to the body—

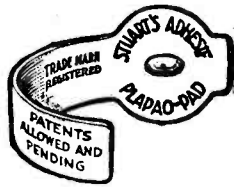

—without straps, buckles or springs.

Easy to apply, comparatively inexpensive and comfortable.

For almost a quarter century stacks of sworn testimonials from many different countries report success, without delay from work. Process of recovery natural, after which no further use for a mechanical support. Test of the remedial herbal factor **FREE** "PLAPAO" sent you absolutely No charge for this now or ever. Write name on coupon NOW and mail TODAY.

Plapao Co., 10 Stuart Bldg., St. Louis, Mo.

Name
Address

Free — Trial Plapao — Free

Outdoor Jobs

Get Forest Ranger, Park Ranger or Game Protector job; \$140-\$200 month; vacation; steady jobs; patrol forests and parks; protect game. Qualify now. Write for full details.

DELMAR INSTITUTE Dept. B-39 DENVER, COLO.

Have you read the story of the OFFICIAL RADIO SERVICE MANUAL on page 314? It's really worth the few moments spent in reading it to learn how valuable it is.

RADIO BARGAINS

Low Power Transmitter adaptable for phone or code. With plug-in coils \$14.75
Auto Radio—Uses 3 224 screen grids, 2 227 tubes and 1 245 power tube, single dial, tremendous volume. Compact. Fits any car. We guarantee this set to perform better than sets selling up to \$150..... 20.00
B Eliminator, Bone Dry with 280 tube, 180 volts, will operate up to ten tube set, fully guaranteed... 6.75
AC—A B C Power Packs 8.75
Tubes: UX type, 30-day replacement guarantee, No. 210, \$2.25; No. 250, \$2.35; No. 281, \$1.85; No. 245, \$1.25; No. 224, \$1.25; No. 227, 75c; No. 226, 65c; No. 171, 75c.
CHAS. HOODWIN CO.
4240 Lincoln Ave. Dept. L-15 Chicago

WE MATCH PANTS To Any Suit!

Double the life of your coat and vest with correctly matched pants, 100,000 patterns. Every pair hand tailored to your measure; no "readymades." Our match sent FREE for your O. K. before pants are made. Fit guaranteed. Send piece of cloth or vest today. SUPERIOR MATCH PANTS COMPANY 115 So. Dearborn Street, Dept. 380, Chicago

I CHALLENGE

you that I will teach you, by mail, in one lesson, the simplest, shortest method. All for \$1.00. Not telepathy. You can read one's mind to a dot, by only looking in the eyes of partner, chum, sweetheart, etc. Praised by New York, Boston, Montreal Police chiefs; colleges; Thurston; Blackstone, etc. If fake, let them arrest me.

A. HONIGMAN, Dept. WSG-11

5390 CLARKE ST. MONTREAL, CAN.

SONG WRITERS!



Substantial Advance Royalties are paid on work found acceptable for publication. Anyone wishing to write either the words or music for songs may submit work for free examination and advice. Past experience unnecessary. New demand created by "Talking Pictures", fully described in our free book. Write for it Today—Newcomer Associates 751 Earle Building, New York, N. Y.

Reversal of Connections

When the ground connection of the battery is changed from positive to negative, what will be the effect on the charging of the battery? Will the generator have to be reconnected, to prevent it from charging the battery backward—that is to say, discharging it? Let us consider this.

Neglecting all resistances in the circuit except those of the battery and generator, let us take these values as .07-ohm for the former and 0.33-ohm for the latter. Since the battery is now connected negative to ground, and the generator positive to ground, the two potentials are in series. The generator, when its output reaches about 12 volts, closes the relay contacts and a heavy current flows. This will be equal to 18 volts (12 volts plus 6 volts) divided by 0.4-ohm (0.33 ohm plus .07-ohm), amounting to 45 amperes.

The voltage drop in the generator will then be, according to Ohm's law, 14.85 volts; and that in the battery 3.15 volts. The voltage drop across the generator then exceeds its generated voltage by 2.85; and the voltage drop in the battery will be less than its generated voltage by the same amount.

This voltage drop, exceeding the generated voltage, in the generator causes a reversal of the current in its field windings; this reversed current reverses the magnetic flux of the field poles, and the generator begins to generate a voltage in opposition to that of the battery. This action takes place inside of two or three seconds; it is, in electrical language, a transient phenomenon.

The generator is now charging the battery, but the current is flowing in a reverse direction; the ammeter leads, therefore, should be reversed in order to correct its reading. The reversal of current flow, however, will not affect the ignition and lighting systems, in which the direction of the current's flow makes no difference.

A second method may be employed to reverse the voltage of the generator, when it is necessary to reverse the battery terminals. Before starting the car, the generator field is reversed by holding the relay contacts closed for about ten seconds; so that the voltage drop of the battery across the generator sends a current through the field.

Finally, another way is to have someone hold the contacts closed while you start the motor up. The reversal of the ammeter would indicate the reversal of the generator. These last two methods are practical, except when the battery is quite run down.

Sometimes, when the first method is followed, the generator voltage will not be reversed. The principal reason is that, the voltage drop across the generator did not exceed the voltage which it generated; and this will be found due to a high-resistance contact, somewhere, which has absorbed the larger portion of the voltage drop of the circuit. Corroded terminals on the battery, sulphated plates, run-down batteries, loose connections or bad joints, may be looked for. In such cases, the job is out of the sphere of the radio Service Man, and belongs to the automotive Service Man or service station to correct.

SKINDERVIKEN Transmitter-Microphone-Amplifier Units



A FEW USES FOR THESE UNITS

<p>LOUD SPEAKER RETRANSMISSION</p>	<p>PHOTOGRAPH MUSIC AT A DISTANCE</p>
<p>GRID LEAK</p>	<p>RADIO AMPLIFIER</p>
<p>TALKING LIGHT</p>	<p>DETECTOR</p>
<p>CODE PRACTICING DEVICE</p>	<p>BALDWIN PHONE AMPLIFIER</p>

HUNDREDS OF USES FOR THE EXPERIMENTER:

- RADIO AMPLIFIER
- DETECTAPHONE
- STETHOSCOPE
- MICROPHONE
- PHONOGRAPH AMPLIFIER
- TELEPHONE AMPLIFIER
- LOUD SPEAKER AMPLIFIER
- CRYSTAL SET AMPLIFIER

WE PAY \$5.00 IN CASH for every new use developed for this unit and accepted and published by us.

95c EACH Two for \$1.75
12-PAGE INSTRUCTION BOOKLET containing suggestions and diagrams for innumerable uses, furnished with each unit.

EVERY AMATEUR SHOULD HAVE TWO OR THREE OF THESE AMPLIFIERS IN HIS LABORATORY

SEND NO MONEY

When the postman delivers your order you pay him for whatever you have ordered, plus a few cents postage.

PRESS GUILD, Inc. RC-11-30
16 Murray St., New York, N. Y.

Please mail me at once as many of the following items as I have indicated.

...Skinderviken Transmitter Units at 95c. for 1; \$1.75 for 2; \$2.50 for 3; \$3.20 for 4.

When delivered I will pay the postman the cost of the items specified plus postage.

Name
Address
City..... State.....

"Roll Your Own" Super

(Continued from page 286)

stage progressively. Fig. 2 shows the arrangement which I found most satisfactory. Care should be taken with the shielding of L4 and its associated screen-grid amplifier V4. I used wing shields only between the two R.F. stages, but complete shielding would be better.

It is desirable to employ a carbon-disc rheostat at R2, for the filament of the oscillator tube V8, because a variation in filament temperature changes the generated frequency; experiment with this will soon determine the correct setting. Fixed resistors may be used to govern the temperatures of the other tubes, by providing a 500,000-ohm variable resistor in the R.F. plate lead.

The 3,000-ohm variable resistor may be placed in the rear, on the baseboard; once adjusted, it requires no further attention.

When ready to test the set rotate the left-hand dial a little at a time, and swing the right-hand oscillator dial till a station is heard, or a squall. If the latter, reduce the R.F. filament rheostat, or perhaps the regeneration control R4.

When the station is heard plainly, balance C1-C2-C3 until reception is loudest. Then adjust the I.F. coupler; turn the set screws of C5 and C10 all the way in, and turn back C5 very slowly until the signal is loudest. It may become necessary to reduce the resistance of R4; when it is just below the point of oscillation, adjust C10 in the same way.

Selectivity can be controlled by varying the separation of the windings of L4 (about 1¼ inches was found right for medium selectivity); and the coupling of L5 controls the feed-back.

List of Parts Used

Three *Pilot* .00035-mf. variable condensers (C1-C2-C3), one *Pilot* .0005-mf. variable condenser (C6), and a *Pilot* double drum dial;
Two *X-L* .001-mf. "Variodensers" (C5-C10);
Three *Aerovox* fixed condensers: one .0005-mf. (C4); two .001-mf. (C9-C12);
Three *Tobe* 0.5-mf. fixed condensers (C7-C8-C11);
Four *Pilot* plug-in R.F. transformers (L1-L2 L3-L6);
Three *Pilot* 85-mh. chokes (RFC 1-2-3);
Two 6-ohm filament rheostats (R1-R6), one including filament switch (SW);
One 25-ohm filament resistor (R3) tapped for '22 tube;
One 0-3000-ohm variable resistor (R4) for regeneration control;
One "Bradleystat" filament control (R2);
Two *Pilot* A.F. transformers (T1-T2);
Twelve *Pilot* sockets, for coils and tubes;
One grid condenser (C13) with 2-meg. leak (R5);
One *Jones* 7-wire cable, base mounting;
Two *Yaxley* tip jacks for speaker; two binding posts for antenna and ground;
One 7 x 24 panel and one 10 x 23 baseboard;
Copper sheeting for shielding. The can containing L4 is 5 x 3½ inches by 5½ inches high;
Two home-made I.F. couplers (L4 and L5).

(Continued on page 312)

NEW YORK ELECTRICAL SCHOOL

"Learn by Doing"

Opportunities for ALL MEN!

Every phase of all branches of *Practical Electricity* taught by Actual Practice in America's Foremost Institution of Trade Learning.

Also Special Courses in *Automobile Mechanics* and *Auto-Electricity*.

No books used. Start any day. Day and evening classes open all year. Ask for School Catalog.

New York Electrical School
21 West 17th Street New York City

Metallized RESISTORS make satisfied customers...



Service counts in radio more than anything else. Standardize on *Metallized Resistors* (more are used by service men than any other make).

REMARKABLE BOOKLET

Write for it

Our new Resistor Replacement Guide eliminates any loss of time on a job, which means a greater profit for you. Write today.



MADE BY THE MAKERS OF

Metallized
RESISTORS

INTERNATIONAL RESISTANCE CO.
2006 CHESTNUT STREET PHILADELPHIA, PA.

There's big news on page 298 of this issue—do not fail to read it.



MICROPHONES

For Transmitters — P. A. Systems and Recording, also cables, accessories and repairs. Catalog just out.

UNIVERSAL MICROPHONE CO., LTD.
Inglewood, California

**Radio's
Biggest Values**

Up-to-the-minute offerings at lowest wholesale prices. Includes newest Tone Control, Screen Grid Superheterodyne, Radio-Phonograph combinations, short wave receivers, automobile radios, public address. Attractive walnut consoles and latest accessories, parts and kits. Don't buy until you see our big catalog.

Send for
**FREE
Complete
Catalog**

Western Radio Mfg. Co.
128 W. Lake St. CHICAGO

Hotel Directory of the Radio Trade

The hotels on this and the following pages are patronized by the Radio Trade. Make them your headquarters.

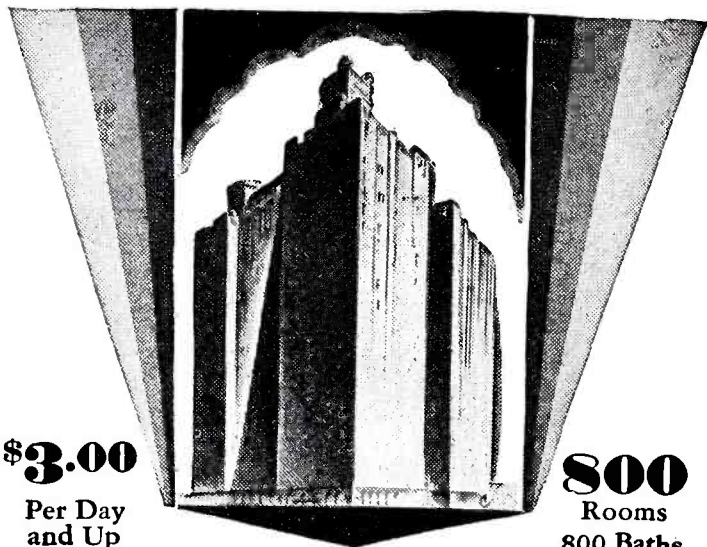

\$3.00
Per Day
and Up

800
Rooms
800 Baths

*Old Fashioned Hospitality
in a Modern Setting*

In the Grand Central Section, 10 minutes from Penn. Station, near Times Square, Fifth Avenue shops and important commercial centres and theatres.

Radio in Every Room

Single Rooms \$3 to \$5 per day
Double Rooms \$4 to \$6 per day

S. Gregory Taylor, *President* Oscar W. Richards, *Manager*

HOTEL MONTCLAIR
49 TO 50TH STS.
AND LEXINGTON AVE
NEW YORK CITY

The **Belvedere**
FORTY EIGHTH STREET
WEST of BROADWAY
New York

Resident and Transient

450 OUTSIDE ROOMS
Each With Bath and Shower
Serving Pantry

\$3 to \$6 PER DAY
Special Weekly or
Monthly Rates

Best Food in New York

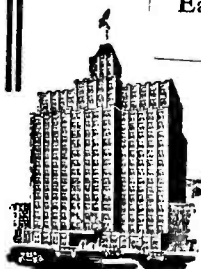

D. M. PEPPER
MANAGING DIRECTOR

Construction of Coils

It is not difficult to construct the I.F. coils. Wind three of 200 turns each and one of 100 turns of No. 36 wire on a 1-inch round form; tie them securely with twine, dip them in melted paraffin and press out while still hot. Hang them up to dry. This makes a neat coil. The mounting method shown in Fig. 3 may be improved on, but is satisfactory.

A piece of hardwood, 1/2-inch square, is cut into four pieces 3 inches long for up-rights and two pieces 2 1/4 inches long for cross bars. It is well to start with a sufficient length to allow for waste.

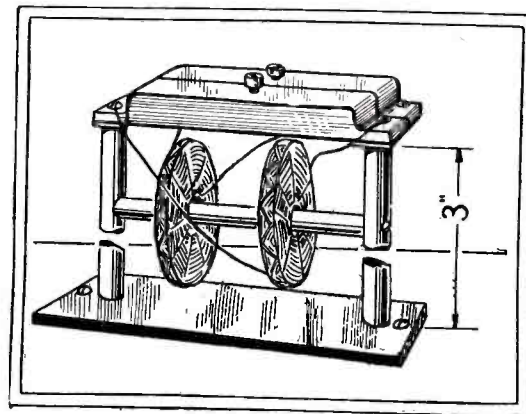

Fig. 3

The I.F. coils are adjusted on the cross-bar as required and tuned with the adjustable condensers.

If you prefer to make your own R.F. transformers, this is easily done. Each has 98 turns of No. 28 D.S.C. wire on the secondary and 20 turns of No. 30 D.S.C. on the primary, separated about 1/8 inch, and wound in the same direction. The form is a 1 1/2-inch tube, 3 1/2 inches long.

The oscillator coil L6 has 50 turns in the grid winding and 30 in the plate winding, both of No. 28 D.S.C. and wound in the same direction; a similar form is used.

Constructors who wish to ask further questions of the writer should do so briefly, on one side of a sheet of paper, and enclose a stamped and self-addressed envelope.

The "Better Booster"

(Continued from page 288)

Assembly of the Booster

As laid out by the writer, the panel was drilled exactly in the center for the mounting of SW2; SW1 was located 1 1/2 inches above it, and SW3 as far below. The holes for the shafts of C1 and C2 were located 3 inches to left and right, respectively, on the horizontal center line. The switches and condensers were then mounted, and the coils L1 and L3 on the backs of the condensers; they may be attached to the base-board as preferred. There is room for the R.F. choke L2 under the right-hand (tuning) condenser C1. The socket for V1 was mounted just behind the center of the base-board, with R1 to the right and R2 to the left. C4 was mounted between the socket and the line of the switches on the panel; C3 between L1 and the terminal strip. These parts may be screwed down, or held by the wiring. As stated above, shielding was not used by the writer, though greater efficiency can be obtained by its proper application.

(If shielding is used, it will be safest to insulate *everything* from the shield; and then ground the shield.) The wiring is then very simple. The terminals, looking at the strip from the back, run from the left thus: aerial, "B+ 135," "B+ 45," "B—," "A+," "A—," and "antenna" lead to set.

SW1 is in the "—A" lead to the tube filament; SW3 is used to cut the booster in and out between antenna and broadcast receiver; and SW2 cuts the wavetrap in and out of the circuit.

Operation

Close SW2 and set SW3 on position 2, and then tune the broadcast set in the regular way for a weak station. Then, open SW2 and adjust C2 until the volume of the weak signal is changed. Now put the booster into operation by closing SW1 and moving SW3 to position 1; tuning the input of V1 for the weak station by adjusting condenser C1. (If L1 and L3 are not shielded, some peculiar tuning effects may be observed, such as exceptional selectivity—the signals "dropping in" and "dropping out" as the tuning is changed—because of "double-hump resonance" due to mutual coupling of the two tuned circuits.—*Editor.*)

If your broadcast receiver is wired with "A+" to "B—," no alteration will be necessary; if it combines "A—" and "B—" terminals, then change the wiring to bring the grid return of the screen-grid tube to "A—."

The coil specifications listed above were suitable for covering the broadcast band with the Atwater Kent "Model 35," the input circuit of which is shown in the sketch (Fig. 2); but with a receiver having a different type of antenna circuit, some change may be necessary, especially in L3.

Volume Control

(Continued from page 287)

down the batteries while the unit is in operation.

The second system adaptable to existing receivers operates in a manner differing from those already discussed. While the others were fed by the un-rectified carrier-wave current, this operates directly from the output of the receiver. The first external unit (Fig. 3) effects its control by variation of the screen-grid potential; while this device, as shown in Fig. 4, decreases the volume by lowering the plate voltage of the R.F. stages.

The second unit, operating from the audio output of the receiver, is particularly adaptable to battery-operated sets. Neither of these two requires any explanation other than that given in the diagrams, as both operate by increasing the drop through a fixed resistance when the plate current through the control tube increases. In the case of the second unit described, the control obtained serves merely to avoid the sudden bursts of sound, so annoying when tuning through locals. The volume control formerly used continues to function as a sensitivity adjustment.

Another arrangement, for use with battery-operated receivers shows the values used with an '01A tube. (Fig. 5.)

HOTEL DIRECTORY OF THE RADIO TRADE

Chicago's Newest Hotels

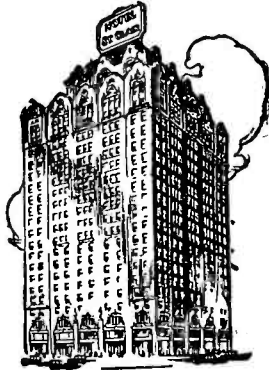

The St. Clair
500 Rooms—\$2.50 up

Hotel Eastgate

Ontario Street, one block East of Michigan

Excellent cuisine, and service perfect to the smallest detail

Just a Step from the Loop

FREE GARAGE
NO INCREASE IN RATES

Free Garage to tourists

St. Clair Hotel

Ohio and St. Clair Streets

Telephone: Superior 4660
Beautiful Dining Room - Coffee Shop - Service Ultra Mode



The Eastgate
300 Rooms—\$2.50 up



Famous

For years as the hotel where courteous service, unexcelled food and comfortable rooms make a visit to Chicago a memorable event. The atmosphere prevailing is surprisingly homelike. Directly adjoining principal office buildings, shops and theatres.

Rooms, \$2.50 up—
with bath \$3.50 up

NEW BISMARCK HOTEL CHICAGO

Write for Booklet with city map

Be sure to read the interesting announcement on page 308 telling how you can get a binder to preserve your copy of RADIO-CRAFT.

Reduced Rates at
CLEVELAND'S
Newest
HOTEL

AUDITORIUM
EVERY ROOM WITH BATH
\$2
\$2.50
\$3

300 Clean Modern Rooms

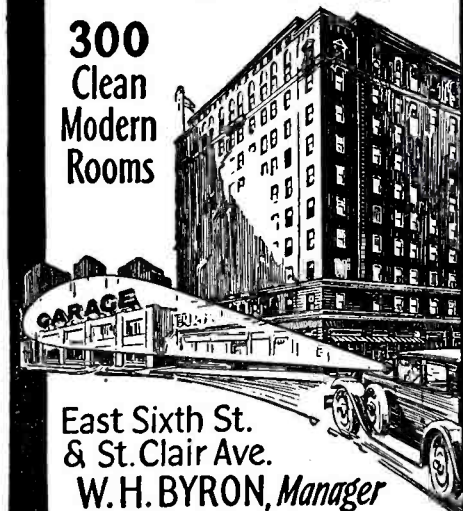

East Sixth St. & St. Clair Ave.
W.H. BYRON, Manager

"Official" RADIO SERVICE MANUAL

and Complete Directory of all Commercial Wiring Diagrams

IN LOOSE-LEAF FLEXIBLE, LEATHERETTE BINDER

OVER 1,000 ILLUSTRATIONS, DIAGRAMS, Etc.

352 PAGES 9" x 12"

Weight 2½ lbs.

HUGO GERNSBACK, *Editor*
CLYDE FITCH, *Managing Editor*

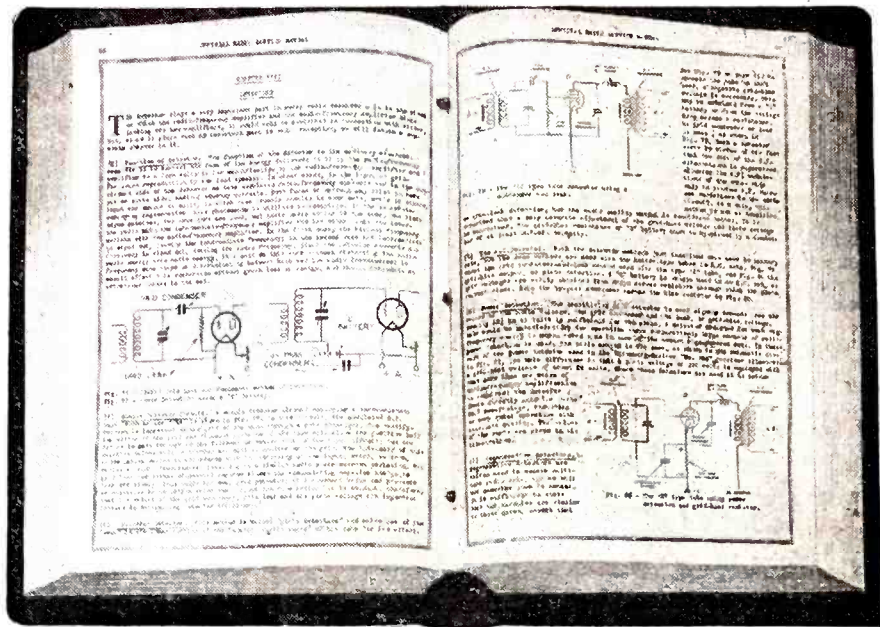

Prepared Especially for the Radio Service Man!

NEVER in the history of radio has there ever been published a service manual, so complete, as this new OFFICIAL RADIO SERVICE MANUAL. It is a veritable encyclopedia of service information—worth several times its price. It is invaluable not only for the Service Man, but for everyone interested in radio.

THE BIGGEST RADIO VALUE IN AMERICA TODAY!

\$3.50 A COPY

There has been collected for this manual wiring diagrams and data of nearly every commercial set, of which there is any available record, manufactured since 1927, and many earlier ones.

The OFFICIAL RADIO SERVICE MANUAL is made in loose-leaf form in a handsome, durable, flexible leatherette binder and contains 352 pages of the large size, 9 x 12.

Additional service data for new receivers, as they appear on the market, will be published and supplied at a trifling cost so that the MANUAL may be kept up-to-date at all times. But that is not all.



SERVICE INFORMATION

The OFFICIAL RADIO SERVICE MANUAL contains also a most comprehensive instruction course for the radio Service Man, giving practical information from every angle on how to service the set. Here are only a small number of the articles mentioned:

- Amplifiers (Audio and Radio)
- Automotive Radio
- Antennas
- Condensers
- Detectors
- Eliminators
- Meters
- Power Supply Systems
- Radio Phonograph Equipment
- Resistors
- Short-Wave Sets
- Speakers
- Tubes

You simply cannot realize what a tremendous work this is until you have held a copy in your hands and have gone through its 352 pages.

Over 1,000 illustrations, diagrams, etc.

WHAT THEY SAY

NOTHING CAN COMPARE WITH IT
I have received my copy of the OFFICIAL RADIO SERVICE MANUAL. I expected it would be good for I think you know as much as any of them what the average radio man wants, but I'll wager not very many expected to receive a book comparable to this one. I think you deserve a lot of credit for being the first to put out a real service manual that the amateur or professional can make good everyday use of. It's a good practical book and one that every service man will be proud of.—E. D. HANA, Haslett, Mich.

BEST BOOK IN THE FIELD
I received your book OFFICIAL RADIO SERVICE MANUAL and I find it is as yet the best book I have found in this field of radio. You are well justified in that this is the peer of service manuals. I wish you all the success possible in the publishing of future books on radio which are sure of great necessity.—WILLIAM R. BROWN, Brown Radio Service, 1010 Buckingham Street, Toledo, Ohio.

WORTH A GREAT DEAL MORE
Received your copy of OFFICIAL RADIO SERVICE MANUAL and am greatly pleased with same. It is worth a great deal more than it costs.—HAROLD AIGUIER, 41 Rutland Ave., Arlington, N. J.

"SHE IS A BIRD"
Just to let you know we received my MANUAL this A.M. and—OH BOY!! She is sure a BIRD! You sure did strut your stuff, AND HOW!!—V. H. HERNDON, Herndon's Radio Shop, Odon, Indiana.

EXTREMELY PLEASED
I acknowledge receipt of the OFFICIAL RADIO SERVICE MANUAL and I am extremely pleased with it.—EDW. JOHN SMITH, 337 E. 26th St., Erie, Penna.

A VERITABLE GOLD MINE
I received the OFFICIAL RADIO SERVICE MANUAL. I am well pleased. It is a veritable gold mine for the Service Man.—EUGENE BINFORD, Arkansas City, Kansas.

MAGNIFIQUE
Received my copy of the OFFICIAL RADIO SERVICE MANUAL this A.M. "She is what you call him? Magnifique! Exquisite!" A timely aid for the troubled sets. Thanks.—E. BOICE, 1118 W. Dauphin, Philadelphia, Pa.

FINEST THING
Just received the RADIO MANUAL. It sure is the finest thing I have seen.—E. J. SCHWARM, 465 Eddy Road, Cleveland, Ohio.

IT ASTOUNDED THEM
Everywhere I have exhibited the MANUAL it has taken the boys by surprise and its completeness has astounded them. For instance, Saturday morning last I had occasion to run into the service plant of the Mackenzie Radio Corp., New York District Distributors for Zenith Radio, in connection with replacement units, and when I showed the Service Manager, Mr. Wandelt, the MANUAL, he was agreeably surprised and called the men to see the work. Delightedly yours, and always a booster for Gernsback Publications, of which I read practically all, and study them.—IRA C. HALDERMAN, 44 Leroy Place, Ridgewood, N. J.

GERNSBACK PUBLICATIONS, Inc., RC-11
96-98 Park Place, New York, N. Y.

As per your special offer, I enclose herewith \$3.50 for which you are to send me postpaid, one copy of the OFFICIAL RADIO SERVICE MANUAL.

Name
Address
City..... State.....

Fifty-Watt Sound Installation

(Continued from page 289)

loud speakers and headphones, especially in conjunction with the requirements of radio-wired hotels, hospitals, schools and other buildings calling for a multiplicity of loud speakers or headphones, it is interesting to note the power requirements of these devices. The usual dynamic reproducer requires from 1 to 3 watts for satisfactory operation, therefore the 10-watt amplifier will operate from four to ten dynamics at full volume. The 2.5-watt power amplifier will operate from one to three, while the 1.6-watt powerizer will operate one or two dynamics. These figures are conservative.

The usual magnetic speaker requires from 0.2- to 0.25-watt input for full volume; which means that a 10-watt output will operate from forty to fifty; a 5-watt output from twenty to twenty-five speakers; and a 2.5-watt output from ten to thirteen magnetic speakers.

The usual pair of headphones requires about 1/200-watt; which means that the 3-watt output will take care of 600; the 5-watt of 1000, and the 10-watt of 2000.

Large Multiple Installations

Since, in hotels, the favorite installation is the magnetic and sometimes the dynamic speaker in each room, with the most powerful forms of dynamics in lobbies, banquet halls and so on, it must be obvious that, with the latest standards of fidelity, the 10- and 15-watt power amplifiers, heretofore considered maximum equipment, are no longer sufficient. Hence the introduction of the 50-watt amplifier by our engineers, for the largest hotel, apartment house, hospital, school and other indoor installations; as well as for airplane landing fields, stadiums, circus and fair grounds and other outdoor uses. In terms of dynamics, the 50-watt output means the operation of from forty to a hundred reproducers, either indoors or out. In the case of the usual "centralized radio," or radio-wired building, it means the operation of four to five hundred magnetic speakers at maximum vol-

ume, or the operation of twenty thousand headphones, or any combination of these two figures. Obviously, we now reach a standard of performance where any conceivable audience, either indoors or outdoors, can be taken care of with a single power amplifier. It is well to note that, in the radio-wired building, all loud speakers are not going at one time. One-third or less of the total number installed will be operating at one time. Hence the capacity of the installation need be for only one third of the total number of speakers installed in the rooms, lobbies, restaurant, and so on.

The 50-watt unit shown here marks the present climax in high-power amplification for standard purposes. This unit is the third audio stage of the complete powerizer system, and employs two UV-845 type amplifier power tubes arranged in push-pull, together with two UX-866 mercury vapor tubes for rectification. The unit is preceded by a driver unit which employs one '27 tube in the first stage, and two '45s in push-pull for the second stage. An '80 tube is used for rectification.

The unit is built up for panel-rack mounting, and is provided with a safety cover which fits over the rear of the amplifier, protecting the tubes and the operator from personal injury. The cover is so designed that, when it is opened in order to insert the tubes, the A.C. power is disconnected from the unit.

The amplifier is provided with an output transformer providing variable impedance combinations, in order to balance with the load; thereby obtaining the maximum transference of energy without introducing distortion. The various output impedances cover the values of 10, 20, 50, 100, 200 and 500 ohms.

Just as we now use 50-watt lamps as our present-day standard of illumination, in place of the old tallow candle, so we shall soon talk in terms of 50-watt power amplifiers for our electrical voice installations. The world does move!

Reviews of Recent Radio Literature

SOUND PICTURES AND TROUBLE SHOOTER'S MANUAL. By James R. Cameron and John F. Rider, published by Cameron Publishing Co., Manhattan Beach, N. Y.; 1120 pages, 5 x 7 1/2 in., 466 illustrations.

In the words of the authors regarding this book, they "—hope to impart sufficient detail so that you" (the projectionist) "will be able to maintain your equipment in better manner, and thoroughly understand the working principles of same. Last, but not means least, we hope to enable you to recognize when the trouble, or repair, if such does arise, is beyond your scope."

There is a nine-page introduction by William F. Canavan, International President of the Society of Motion Picture Engineers. The book contains 55 chapters, followed by a 23-page cross-index of subjects.

The first four hundred pages are devoted to the study of electrical theory. The remaining six hundred or so describe in detail practically every-

thing of interest to the sound projectionist.

A great convenience, for finding a particular subject quickly, is the numerous large-type sub-heads.

The book, some 2 1/2 inches thick, contains valuable reference material never before published and is particularly to be recommended to the man who wants a guide book on practical sound projection.

THE AEROVOX "HI-FARAD" DRY ELECTROLYTIC CONDENSER. This manual is published by Aerovox Wireless Corp., Brooklyn, N. Y.; 32 pages, paper covered, 5 by 7 1/2 in., illustrated. Free distribution.

This manual is not merely a catalog of the Aerovox line of electrolytic condensers, with data for the designing engineer of commercial sets; it contains an analysis of the function of these components, explaining their uses, limitations and characteristics. Operating conditions, test methods, etc., are explained and instructions given as to the employment to best advantage.

DEALERS AND SERVICE MEN:
WE SPECIALIZE IN
REPLACEMENT PARTS

BAL-RAD
Replacement Block for
Atwater-Kent No. 37
This unit contains the proper chokes and high voltage condensers. All flexible wire colored leads identical to the original. Fully guaranteed.
Each..... **\$4.95**

BAL-RAD
Replacement Block for
Majestic "B" Eliminator
The condensers in this block are composed of High Voltage Condensers. Guaranteed for 1 year.
Each..... **\$2.95**

VICTOR CONDENSER BLOCKS
Replacement in All Victor Sets
Contains 10 1/4 mfd.
Our Price..... **\$3.25**

EARL & FREED POWER TRANSFORMERS
For Models 95, 78 and 79, using 5-227, 1-280, 2-245 tubes.
60 cycle \$4.50
25 cycle 4.75
Model 22, using 3-226, 2-171A, 1-280, 2-227 tubes.
60 cycle \$3.50
25 cycle 3.75

R.C.A. REPLACEMENT 600V CONDENSER BLOCK
FOR RADIOLAS Nos. 18, 33 and 51
Part No. 8333
Special, Each..... **\$1.50**

THORDARSON POWER TRANSFORMERS
For Replacement in Zenith Sets
Models ZE 10-33-33X-34. This transformer can also be used for circuits employing the following type tubes: 5-227-1-171A-1-280.
Our Price..... **\$3.50**

VICTOR PUSH-PULL TRANSFORMER
INPUT AND OUTPUT
Can be used with 171A-245 or 250 type tubes. Output matches moving coil on all dynamic speakers
With Metal Jacket **\$2.50** Without Metal Jacket **\$1.75**

BAL-RAD HY VOLTAGE SURGE-PROOF CONDENSERS
For General Repair and Power-Pack Work
We guarantee these condensers for 100 per cent. free replacement. Repair man should carry a few dozen in stock.
Each
One Mfd. 600 Working Volts 30c
Two Mfd. 600 " " 40c
Four Mfd. 600 " " 60c
One Mfd. 800 " " 50c
One-half Mfd. 300 " " 25c

R.C.A. By-Pass Condenser
Part No. 5996
Comprising one 1/2 and three .1 mfd. condensers.
List \$3.00—Each..... **35c**

R.C.A. DOUBLE FILTER CHOKES
Part No. 8336
R.C.A. Replacement Part No. 8336 contains two 30 henry 80 ml chokes. Each insulated for 1,00 volts.
Each..... **95c**

PIGTAIL CARBON RESISTANCES
1000 ohm 15000 ohm 10000 ohm } **\$1.25**
500 ohm 25000 ohm 20000 ohm } Per doz.
4700 ohm 2 megohm 75000 ohm }

TERMS: 20% with order, balance C.O.D. 2% discount allowed for full remittance with order only.
NO ORDERS ACCEPTED FOR LESS THAN \$2.50
BALTIMORE RADIO CO.
47-R Murray Street, New York City
Send for our latest Bargain Bulletin

HAMS! SERVICEMEN!

FRESHMAN power packs. Brand new and in original sealed cartons; originally used in Freshman N11 and N12 sets. Can be used to power a 210 oscillator for a 210 or 250 power amplifier. D.C. output is 500 Volts, at 70 Mills, with taps at 135 and 50 Volts. A.C. output is 7 1/2 center-tapped for two 210s or 250s. 2 1/2 center-tapped for 227s, two 1 1/2 center-tapped windings for 226s. Uses a 281 as a rectifier, has a plug for the D.C. field of an electro-dynamic speaker. Price, less tube \$10.75

COLUMBIA SPECIALTY CO. 1038 Longwood Ave. - New York City

BARGAINS

Regular SILVER SHIELD Vacuum Tubes - 100% replacement within three months provided they still light.

Table listing vacuum tube types and prices: X201A \$0.35, X226 .40, Y227 .50, Y224 .75, X245 .50, X280 .75, X171A .50, X112A .50, X281 1.05, X250 1.25, X210 1.25, UX199 .60, UV199 .65, UX120 .65, WD11 .75, WD12 .75

NO LESS THAN SIX TUBES SOLD AT ONE TIME

All products shipped C.O.D. immediately upon receipt of order

GRENPARK COMPANY

Dept. RC-11 245 GREENWICH ST., NEW YORK CITY

ALUMINUM BOX SHIELDS

Beautiful silver dip finish, 5" x 9" x 6" \$1.89; 6" x 14" x 3", chassis, \$3.45. We make any size to order in 24 hours. Pilot Double Drum Dials; Pilot Plug-in Transformers; Pilot R.F. Chokes, 69c.; X-L Variometers; Jones 7-wire Cables, \$1.00; Neon test lamps, vest pocket size, \$1.00; 44 grooves per inch 1 1/2-in. coil form, 45c. Please include postage. BLAN, The Radio Man, Inc. 89V Cortlandt St., New York, N. Y.

EVERYTHING IN RADIO

Attractive Prices Sets or Parts We make a specialty of Special Service. We ship everything available in this city. Inquiries invited. ALL RADIO, 417 North Clark St., Chicago.

RADIO-CRAFT'S INFORMATION BUREAU

(Continued from page 290)

is pressed against the shields.) This should clear up the cause of the particular circuit oscillation referred to above.

NOTE: Make certain that the bottom plate is bolted tightly in place, as this is part of the shielding system.

"Phasing," also termed aligning, trimming, or balancing of the tuning of each of the tuned R.F. circuits, by adjustment of the trimming (or "phasing") condensers; on the "950" these are found on the left side of the gang tuning condensers.

To balance the tuned circuits (a procedure to be ventured upon only when the tuned circuits are definitely known to be out of resonance) an audio-modulated oscillator will be required.

Leaving the ground connected, but with the set turned on and the aerial disconnected, couple the set to the oscillator and adjust the receiver dial for 1,000 cycles; then tune the oscillator to this frequency, with the volume control of the receiver on full. (Control the volume of the oscillator by some adjustment in the oscillator or by changing coupling, but not by variation of the volume control on the set.) Carefully balance the antenna trimming knob.

(Continued on page 318)

Now, bring an insulated piece of metal, such as a tape-covered hack-saw blade, close to the detector-circuit tuning condenser, through the stator plates at the left side; so that the blade can make contact at its lower end with the upper left rim of the condenser frame. This added capacity should cause the signal to decrease. If there is no change of signal strength, or an increase in strength, this indicates that the circuit is out of resonance and should be aligned by the trimming condenser at the left. (The coupling condensers at the right, of 16 mmf., are set at the factory and should not be touched). Repeat this procedure for RFT3 and RFT2; the circuit of RFT1 is taken care of through the panel condenser control.

This is the check for high capacity in the tuning condensers; the test for low capacity follows the same routine, with the tuning dial adjusted off the 1,000 kc. setting by two degrees. If the signal does not become louder, carefully adjust the trimming condenser in shunt with the tuning condenser under test.

If the tuning dial scale is not in the proper position for a given frequency, there is provision to re-set it.

Short-Wave Stations of the World

(Continued from page 284)

Table listing short-wave stations worldwide with columns for Kilo-Meters, Meters, and station call letters. Includes stations like W3XAL, W9XL, W6XBA, etc.

DRASTIC PRICE REDUCTIONS

ON NATIONALLY ADVERTISED RADIO GOODS — FULLY GUARANTEED!

The STANDARD BATTERY RECEIVERS listed below are priced ridiculously low only because they are store demonstrators. HOWEVER, WE GUARANTEE THEM TO BE IN PERFECT WORKING ORDER! THEY ARE LIKE NEW IN MOST INSTANCES — IF YOU ARE NOT FULLY PLEASUED WITH YOUR PURCHASE,

YOUR MONEY WILL BE IMMEDIATELY REFUNDED! By using appropriate "A" and "B" eliminators, any of these sets can be operated RIGHT FROM ANY A.C. LIGHT SOCKET! The parts alone in these sets are worth MANY TIMES OUR SALES PRICES!



RADIOLA SUPER-HETERODYNE MODEL 25
Uses 6 - 199 dry-cell tubes. Coast to coast reception! Extreme sensitivity and selectivity. No aerial required. List \$265.00.
YOUR PRICE... \$10.95
With Loop



STROMBERG-CARLSON
3 Stages T.R.F. INDIVIDUAL STAGE SHIELDED! Uses 5 - 201A, 1 - 171A tubes. Extreme long distance reception!
List \$245.00.
YOUR PRICE \$29.85



FRESHMAN MASTERPIECE
Separately tuned R.F. stages—vernier dial controlled. Most efficient circuit gives superior results—plenty of volume and long distance reception. Requires 4 - 201A, 1 - 171A tubes.
List \$80.00.
YOUR PRICE \$7.00
Original model — plain bakelite dials
YOUR PRICE \$5.00



RADIOLA SUPERHETERODYNE AR-812
Built-in loop. Miraculous sensitivity and selectivity. Uses 6 - UV199 tubes.
List \$220.00.
YOUR PRICE \$10.95



ATWATER KENT 20 COMPACT
Famous distance reception set. Separately tuned R.F. stages permit maximum sensitivity and selectivity. Requires 5 - 201A tubes.
List \$60.00.
YOUR PRICE \$10.95



ATWATER KENT MODEL 35
Most compact T.R.F. set made. Just as efficient as any big set. Single dial control. Metal case. Requires 5 - 201A, 1 - 171A tubes.
List \$65.00.
YOUR PRICE \$14.95



GREBE SYNCHROPHASE
Single dial, or 3-dial control, on one panel! Very elaborately designed and built. Unusually efficient! Requires 4 - 201A, 1 - 171A tubes.
List \$100.00.
YOUR PRICE \$19.85



FREED-EISEMANN MODEL 30
A very late model—offers every known improvement. Duplicates performance of most costly receivers made to-day! Requires 5-201A, 1-171A tubes. List \$125.00.
YOUR PRICE \$12.50

SEND - FOR - FREE - CATALOG - SURPLUS - BARGAINS

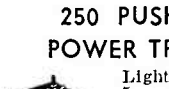

250 PUSH-PULL A.C. POWER TRANSFORMER
Lights 2 - 250, 2 - 281, and 5 - 224 or 5 - 227 (2½ volt) tubes. Also furnishes 650 volts on each side of center tapped secondary. Fully shielded. Terminal board strip with lugs. For 110 volt, 50-60 cycle A.C.
YOUR PRICE..... \$5.95

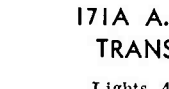

171A A.C. POWER TRANSFORMER
Lights 4 - 226, 2 - 227, 2 - 171A, 1 - 280 tubes. Also furnishes 300 volts each side center tapped high voltage winding. Ideal for replacement purposes. For 110 volt, 50-60 cycle A.C.
YOUR PRICE..... \$2.95

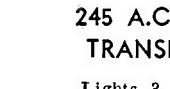

245 A.C. POWER TRANSFORMER
Lights 3 - 224, 2 - 227, 2 - 245, 1 - 280 or similar 2½ volt combinations. Also furnishes 300 volts each side of center tapped high voltage winding. For 110 volt, 50-60 cycle A.C.
YOUR PRICE \$3.25

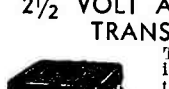

2½ VOLT A.C. FILAMENT TRANSFORMER
Two secondary windings, both center tapped. Lights 6 - 227 or 224 on one, and 2 - 245 tubes on other. For 110 volt, 50-60 cycle A.C. Total cap. 14 amps.
YOUR PRICE \$3.15
For 1½ volt, 2½ volt and 5 volt tubes
YOUR PRICE \$3.95



FILTER CONDENSER BLOCKS
FREED-EISEMANN Model: Contains 1 - 4 mfd., 1 - 2 mfd., 3 - 1 mfd., 1 - 5 mfd., 1 - .1 mfd.
For MAJESTIC "B" ELIMINATORS..... \$2.95
For ATWATER KENT SETS No. 37. Includes two built-in filter chokes..... \$4.95
For MAJESTIC "A" Eliminators..... \$3.25
WE CAN SUPPLY ANY TYPE BLOCK



HY-VOLTAGE UNCASSED CONDENSERS
Ideal for repair work. Impregnated in pitch. For all power packs.
.5 Mfd. 25c
1 Mfd. 30c
2 Mfd. 40c
4 Mfd. 60c



THORDARSON POWER COMPACTS
Contains two chokes as well as A.C. Power transformer.
R-171..... \$5.95
R-210..... \$6.95
R-245..... \$14.70



4 GANG BATH-TUB VARIABLE CONDENSER
Very strongly made and carefully calibrated. .00035 mfd.
YOUR PRICE \$1.50



LOFTIN-WHITE LICENSED DIRECT COUPLED AMPLIFIER
Requires 1-224, 1-245, 1-280 tube. Auditorium volume! Ideal phonograph amplifier. Use with any tuner output!
YOUR PRICE... \$16.50



WEBSTER 2 STAGE POWER AMPLIFIER AND "B" SUPPLY
Requires 2-226, 2-210, 1-281 tubes. Tremendous amplification! Also furnishes "B" current; 45, 67, 90, 135 volts for tuner.
List \$72.50.
YOUR PRICE..... \$19.05



SILVER-MARSHALL 679 2 STAGE AUDITORIUM AMPLIFIER
Requires 2-281, 1-226, 1-250. Use as phono. amplifier, or with a microphone, or attach to any tuner output. The last word in super-power amplifiers!
List \$125.00
YOUR PRICE..... \$22.50



GUARANTEED RADIO TUBES
Return in 30 days after receipt if not fully satisfactory!
Types: 226-227-171A 45c
Types: 201A-112A-200A-199UK-199UV-120 58c
Types: 224-222-245 66c
Types: 210-250-281 \$1.65



RELIABLE SET ANALYZER — TUBE TESTER
Perfect copy of most expensive and elaborate, similar appearing instruments! Guaranteed 100% Accurate! Makes All Possible Tests on Sets or Tubes! Complete with push-buttons, continuity cables, etc., all in leatherette carrying case.
YOUR PRICE..... \$11.95



R.C.A. SPEAKER CHASSIS \$375
Same as used in Model 100 B and 103, R.C.A. speakers. Note built-in output transformer—huge magnets — self-baffling metal housing. 9 in. diameter, 4½ in. deep. Enormous volume output with no distortion or rattling. (Fancy grill front cabinet—97c extra!)



A.C. SYNCHRONOUS PHONO. MOTOR
Most compact made — only 1¼ in. thick. Revolves exactly 80 turns per minute despite voltage variations.
For 110 volt, 60 cycle A.C.
YOUR PRICE \$4.45



PACENT PHONO. PICK-UP
World renowned "PHONOVOX" Back of pivot arm is properly weighted for counterbalance. Extremely sensitive — reproduces perfectly!
YOUR PRICE..... \$4.85



B.B.L. GIANT SPEAKER CHASSIS
Provides DYNAMIC like reproduction without field current! 3 tap impedance switch built-in matches speaker TO ANY SET! 12 in. diameter. Note sturdy construction
YOUR PRICE..... \$7.22



FARRAND INDUCTOR DYNAMIC CHASSIS
No field current required. Reproduces in dynamic-like manner. Can handle output of any set. (Ac or battery) without distortion or rattling. 9 in. diameter O.D.
YOUR PRICE..... \$8.49



PEERLESS DYNAMIC SPEAKERS
14 in. 110v. D.C. \$12.95
12 in. 110v. A.C. 14.50
12 in. 110v. D.C. 8.50
12 in. 6v. D.C. 8.50
9 in. 110v. D.C. 6.50
15 in. 110v. D.C. combin. 800 and 4,000 ohms field. Input trans. 16.95

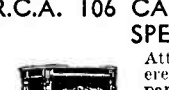

R.C.A. 106 CABINET DYNAMIC SPEAKER
Attractive tapestry covered front and side panels. Walnut cabinet, 33 in. high, 24 in. wide, 11 in. deep. Ample space to build in separate units, tuner and amplifier. Produces tremendous sonorous volume, without distortion! For 110 volt, 60 cycle A.C.
Reg. \$85.00
YOUR PRICE \$14.50



RELIABLE ELECTROLYTIC CONDENSERS
Dry-mount in any position! Self heating-never blow-out! 500 volt D.C. peak rating. Use 2 in series for 250 packs.
1 mfd.27c
2 mfd.44c
4 mfd.83c
8 mfd. \$1.23
16 mfd. 2.09
24 mfd. 2.70



AUDIO TRANSFORMERS
Nationally known makes. All capable of high amplification, without distortion. On orders for 2-4-6-8 etc. pieces, only Matched Pairs are shipped!
YOUR PRICE..... 97c each

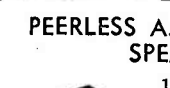

PEERLESS A.C. DYNAMIC SPEAKER
16 in. high. Contains matched input transformer, rectifier unit and step down transformer. The finest speaker ever made! For 110 volt, 60 cycle A.C. List \$75.00.
YOUR PRICE.... \$14.45



RADIO TOOL CHEST
Contains 3 and 5 inch screw drivers, scriber, reamer, countersink, pliers, center punch, socket wrench set for hex and knurled nuts, and 3-¼ in. to ½ in. nut wrenches.
YOUR PRICE..... \$2.30

ORDER FROM THIS PAGE

NO ORDER ACCEPTED FOR LESS THAN \$3.00. WE ACCEPT CHECKS, MONEY ORDERS AND STAMPS IN ALL DENOMINATIONS. INCLUDE POSTAGE ALLOWANCE — ANY EXCESS REFUNDED. IN ABSENCE OF POSTAGE ALLOWANCE, SHIPMENT WILL GO FORWARD, EXPRESS COLLECT. C.O.D. SHIPMENTS MADE — CUSTOMER PAYS ALL C.O.D. FEES. WE GUARANTEE COMPLETE SATISFACTION ON EVERY PURCHASE!

RADIO SURPLUS CORP.

56-R-VESEY ST. NEW YORK CITY

SEND NO MONEY

Radio Set Analyzer and Tube Tester No. 250.



Our Special Price \$11.95

No. 250 Model

Reg. Price \$25.00

THIS reliable meter selling for considerably less than many others on the market meets the demands of every service man most efficiently. Its sturdy construction and accuracy in testing voltages, tubes, open circuits, etc., assures you satisfaction and long use. This meter is identical in construction and resembles others which wholesale from \$60 to \$100.

WHAT IT DOES FOR YOU!

- Shows A.C. and D.C. Filament Voltages
Tests Plate and Grid Voltages (also Screen Grid Voltages)
Indicates Plate Current and Line Voltage
Shows Open Circuits and Grounds
Tests A.C. and D.C. Tubes
This exceptionally fine meter makes every essential test on the radio set.

250 PUSH-PULL POWER TRANSFORMERS

For 2 - 250, 2 - 281, 5 - 227 Tubes Price \$4.50

COMBINATION "A B C" AIREX POWER PACK

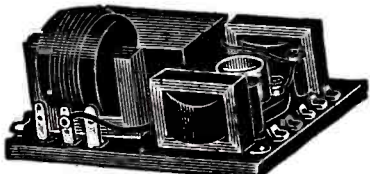

Price Now \$6.75

WIRED READY FOR USE

Built with high-grade parts. Supplies "A, B, C" Voltages for 5-226's 2-227's 2-171-A's 1-280 105-120 Volts - 50-60 Cycle Delivers over 125 Mils and up to 300 volts "B" power. The Power Transformer is designed to take care of a D.C. DYNAMIC SPEAKER, two connections being provided on the pack for same. It need not be used if not wanted, but may come in handy at some future date.

All products shipped C.O.D. immediately upon receipt of order

Grenpark Tool Company 245 Greenwich St., New York City

Should the receiver tune a little too broadly after a careful lineup as described above, a poor ground system may be the cause. Otherwise, the aerial is probably too long, or close to a metal roof, trees or light lines. A defective tube may also be the cause.

AUTOMOTIVE RADIO

(94) Dr. Jac. J. Diederich, Chicago, Ill. (Q.1) In the June, 1930, issue of RADIO-CRAFT Mr. Samuel Egert described a simplified automotive radio receiver. Please explain how circuit oscillations in one of these receivers could be stopped.

(A.1) The author advises that this may be corrected by shielding the connections from the secondary of the radio-frequency coil to the grid connections of the first three (type '24) screen-grid tubes. This shield is to be grounded to the metal chassis of the set. It would be well to check the bypass condensers for open circuit. If the tubes are new, their emission may be higher than normal—a condition which will correct itself in a short time. Grid and plate leads must be short.

(Q.2) What is the recommended length of aerial for an automotive radio set, when under test in the laboratory?

(A.2) The recommended length of aerial for the radio receiver described in the issue referred to will be about 3 to 5 feet. This closely approximates the electrical constants of a car antenna. A longer aerial may cause the circuit to oscillate. It should be noted that these data are applicable to most car radio sets.

RADIOLA III

(95) Mr. John Reilly, New York City. (Q.) Please show the circuit changes necessary to use '99 tubes in a Radiola III, instead of the type WD11 tubes for which it was designed.

(A.) The tubes suggested may be used in this set with two dry cells connected in series as an "A" battery; they may be fitted into the socket by the use of standard "adapters" ("Na-ald," for example) made for this purpose.

RADIO EMPLOYMENT WANTED

The writers of any of these requests may be addressed as Opportunity No. (number given below) in care of RADIO-CRAFT, 98 Park Place, New York City.

(Opportunity 88) Service Man, six years' factory and shop experience, on all makes sets, electric and batteries, desires to locate in medium-size town in South or West. Will furnish test and equipment tools. Age 22. Married. (Illinois.)

(Opportunity 89) N. R. I. graduate, student operator, wishes position in factory, laboratory or broadcast station. Age 2. Married. (Oregon.)

(Opportunity 90) Operator, amateur, seeks position giving experience in broadcast or commercial station operation, preferably in Northwest. (Montana.)

(Opportunity 91) Service Man, three years' experience, high school graduate, wants year-round location in service and repair work. Has Weston "547" set tester. Age 23. Married. (South Dakota.)

(Opportunity 92) Radio man, 3 1/2 years' factory inspection experience (two as assistant foreman), 1 1/2 business for self, R. C. A. Inst. student, wishes connection factory, laboratory or broadcast station, with chance of advancement. Can qualify as foreman. Age 27. Single. (New York State.)

(Opportunity 93) N. R. I. graduate, eight years' radio experience, wishes factory position with chance for advancement, anywhere. Will work long hours if necessary. Age 23. Married. (Connecticut.)

HAM CORRESPONDENTS WANTED

Editor, RADIO-CRAFT:

I am very much interested in short waves, and would like to see more published about them. In fact, I am experimenting and working on ideas day and night; and have a bunch of data that I have picked up; but I am always on the lookout for more.

I wish you would place my name on the list for correspondence on transmitter data; I would like to exchange a few ideas with other readers. Wishing RADIO-CRAFT all luck.

W. A. ELMORE, 113 Fairley Street, Laurinburg, North Carolina.

Increase Your Earning Power

Whatever your job, you will find in EVERYDAY MECHANICS labor-saving kinks which will help you to get more work done in less time and will bring you recognition from your employers. If you do machine shop work of any kind, auto repairing, sheet metal work, electrical work, farming, concrete work, carpentering, tool making, poultry raising, painting, plumbing, masonry, building, glass work, welding, or general repairing, a yearly subscription to EVERYDAY MECHANICS will pay for itself a thousand times over.

15c The Copy

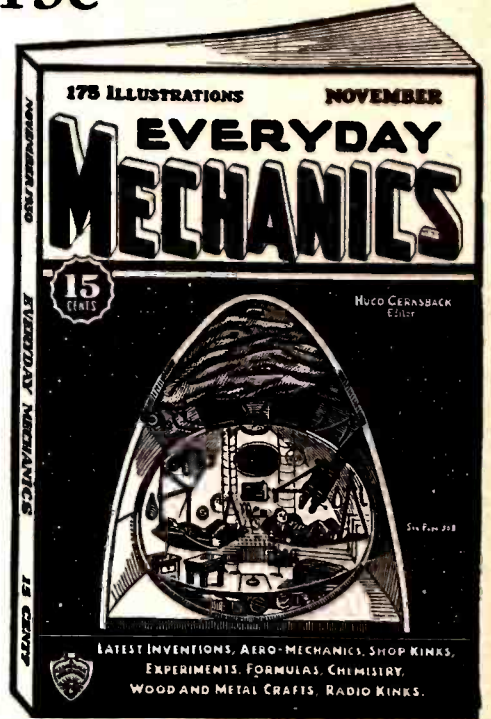

On All Newsstands

Make Money in Your Spare Time

Hundreds and thousands of amateur mechanics and spare-time workers are making \$10 to \$100 a week EXTRA MONEY by servicing vacuum cleaners and washing machines; repairing automobiles; manufacturing book-ends, lamp-shades, tool chests, chairs, tables, unique ornaments, concrete articles, photo frames, flower boxes, gliders, and innumerable products in everyday use. EVERYDAY MECHANICS teaches you HOW to turn your spare time into MONEY.

Contents

SPACE DOES NOT PERMIT US TO PRINT ALL THE FEATURES IN THE CURRENT ISSUE OF EVERYDAY MECHANICS. But the following titles will give you some indication of the interesting and valuable contents: Automobiles, Aviation, Chemistry, Construction Work, Electricity, Magic, Metal Work, Radio, Photography, Shop Work, Woodworking and new devices.

A Special Offer

In order that you may not miss any of the splendid features now appearing in EVERYDAY MECHANICS and opportunities for making money from the unique "tips" that are published in every issue, the publishers will send this valuable magazine DIRECTLY TO YOUR HOME every month at a reduction of ONE-THIRD off the usual subscription price. But to take advantage of this offer you must act quickly. Tear out the coupon below and mail it today. YOUR FIRST COPY OF EVERYDAY MECHANICS WILL BE SENT YOU BY RETURN MAIL.

Mail Coupon Today

EVERYDAY MECHANICS PUB., Inc., 96-98 Park Place, New York, N. Y. RC-11 Please rush my first copy of EVERYDAY MECHANICS. I enclose

- \$1.00 for one year's subscription
1.90 for two years' subscription
2.70 for three years' subscription

(Check one of the above)

NAME

ADDRESS

CITY..... STATE.....

NOTE: This special subscription offer may be withdrawn at any time.

OUR PRICES TALK

NEVER in the history of radio have you seen such values as the ones quoted in this advertisement. Never will it be possible for you to buy brand new radio merchandise at such ridiculous prices. This company is known for prompt shipments, low prices and remarkable values. **WE HAVE AS YET TO RECEIVE OUR FIRST COMPLAINT.** WE BUY AND SELL FOR CASH. We do not have large quantities of this merchandise on hand. First come, first served.

Every month we publish a new list of bargains. **WATCH THIS PAGE.** All articles shown on this page are **BRAND NEW MERCHANDISE** in original cartons, sold at prices never attempted heretofore. Inasmuch as the supply is limited, we reserve the right to return deposits if items have been sold out. Every article is fully guaranteed, yet all merchandise shown here is sold far below actual manufacturing cost. **WE HAVE NO CATALOG. ORDER DIRECT FROM THIS PAGE.**

Allen Hough ROTROLA



This remarkable new instrument enables you to play phonograph records through your radio loud speaker. Plugs into any radio set, whether same uses batteries or A.C. Connected to your radio in a jiffy. Equipped with fine electric

motor operating only on A.C., 60 cycles, 110 volts. New Webster pick-up; volume control; special constant speed electric motor; automatic stop which operates on all records. Beautiful portable cabinet. Full bronze trimmings. In factory sealed case. Shipping weight 18 lbs. List Price \$45.00.
YOUR SPECIAL PRICE..... \$13.50

Utah Dynamic A.C. Power Speaker—Model 33A

110-volt, 60-cycle A.C. light socket supply for field excitation using Westinghouse dry rectifier. 9 in. high, 9 1/2 in. wide, 7 1/2 in. deep. Speaker comes packed in wooden crate. Weight 19 lbs. It is one of the most powerful as well as best reproducers in the market. 9-inch cone. List Price \$50.00.
YOUR SPECIAL PRICE..... \$7.50

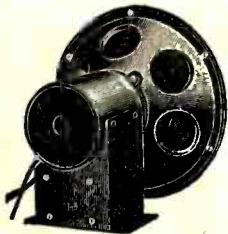

R.C.A. Loud Speaker 100B



A modern design loud speaker which will fit the modern trend in any home, yet harmonizes well with any set. Reproduces tones faithfully over a wide range and possesses great sensitivity. Handles a substantial volume of tone with remarkable clarity.

Magnetic unit. Corrugated cone. Height, 10 1/2 in.; width, 10 in.; depth, 6 1/4 in. Shipping weight 12 lbs. List price \$17.50.
YOUR SPECIAL PRICE..... \$4.85

R.C.A. Double Filter Chokes (No. 8336)

This heavy-duty, extremely strong, double filter choke can be used for all types of filter circuits, experimental work, power amplifiers, receivers, eliminators, power packs, converted sets, etc. Known as R.C.A. replacement part for all Radiola models, particularly Nos. 33, 17 and 18. Each choke is designed for 1,000 volts, D.C. resistance, 500 ohms.



Connected in parallel, these double filter chokes have a capacity of 30 Henries at 160 Mills; connected in series, 60 Henries at 80 Mills. Fully shielded in heavy metal case with special insulating compound. Size 5 1/4 x 3 1/4 x 2 1/4. Shipping weight 6 lbs. List Price \$10.05.
YOUR SPECIAL PRICE..... \$1.10

250 Push-Pull A.C. Power Transformers



Ideal for use in short wave transmitters, public address amplifier systems, super-power amplifiers, A.C. receiver power packs, etc. **EMPLOY HIGHEST GRADE MATERIALS AND LABOR — FULLY GUARANTEED!** Has FOUR CENTER TAPPED secondary windings: 2 1/2 volts, 8.75 amps.—7 1/2 volts, 2 1/2 amps.—1200 volts; designed for two 281, two 250 and five to six 2 1/2-volt A.C. tubes (224's or 227's) or 226 tubes if a suitable resistance is used. **FULLY SHIELDED!** Soldering lug terminals. CAPACITY: 135 WATTS. Size 6 1/4 x 4 1/4 x 4 1/4 inches. For 110 volt, 60 cycle, A.C. Shipping weight 18 lbs. List Price \$20.00.
YOUR SPECIAL PRICE..... \$5.65

Best Theatre Pickup



Best makes the best pickup anywhere. From a whisper to a thunderous volume. With this marvelous pickup you get tremendous volume, enough to tax the capacity of any speaker—and with the softest tonal quality that will surprise a musician. Pickup comes complete with volume control and adapter for four or five prong tubes (in case your set has no phonograph jack.) In original factory sealed cartons. Shipping weight 3 lbs. List Price \$17.50
YOUR SPECIAL PRICE..... \$5.75

Peerless D.C. Dynamic Speaker

The ideal speaker for cabinet installation. Field resistance of 2,500 ohms —90-120 volts. With input transformer. This speaker can be used with A.C. receivers that are equipped to supply the "B" current to speaker field. Speaker comes to you packed in factory-sealed cartons. Shipping weight 18 lbs. 9-in. cone. List Price \$40.00.
YOUR SPECIAL PRICE..... \$6.50

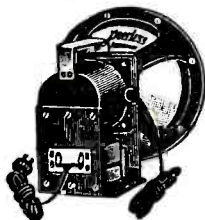

Shipping weight 18 lbs. 9-in. cone. List Price \$40.00.
YOUR SPECIAL PRICE..... \$6.50

R.C.A. Loud Speaker 103



A beautiful speaker in appearance. Superb in its ability to reproduce music and speech most faithfully. The frame and pedestal are mounted to resemble hand-carved oak, while the beautiful tapestry medallion conceals the mechanism and completes the decorative design of the

Instrument. Magnetic unit. Corrugated cone. Height 15 in., width 13 1/2 in., depth 6 3/4 in. In factory sealed carton. Shipping weight 14 lbs. List Price \$22.50.
YOUR SPECIAL PRICE..... \$5.20

R.C.A. 600 Volt Replacement Condenser Block (No. 8333)

For Radiolas 18, 33 and 51. Over a half a million of these different types of Radiola receivers are on the market. Every serviceman needs these blocks, but they can of course be used for other purposes, such as experimental or converting battery sets for power. Size 3 1/4 x 2 3/4 x 3 1/4 inches. Shipping weight 4 lbs. List Price \$7.40.
YOUR SPECIAL PRICE..... \$1.45

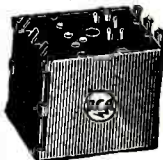

245 A.C. Power Transformer

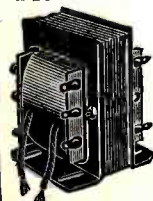

For five 224 (or five 227), two 245, one 280 A.C. tubes, OR ANY COMBINATIONS OF 2 1/2-VOLT TUBES. All secondary windings CENTER TAPPED. 600-VOLT HIGH VOLTAGE SECONDARY. 75 WATT CAPACITY. Size 5 1/4 x 4 1/4 x 3 1/2 inches. For 110 volt, 60 cycle, A.C. Shipping weight 12 lbs. List Price \$15.60.
YOUR SPECIAL PRICE..... \$4.45

A.C. Filament Transformer

Two windings, both center tapped. One "lights" six 227 or six 224 2 1/2-volt tubes. and the other lights two 245 tubes (not used with Webster amplifier). Total: 14 amps. For 110 volt, 60 cycle, A.C. Size 4 1/4 x 2 1/4 x 3 1/4 inches. Shipping weight 6 lbs. List Price \$10.00.
YOUR SPECIAL PRICE..... \$2.75

Atwater Kent Approved Dover Model 133 Console



Made from selected Veneers of Walnut with a two-tone routing and other attractive decorations on the front with a heavy, full-bodied, hand-rubbed and polished varnish finish. Size: top 16x25 1/2 in., height 38 in., width 24 1/2 in. Shipping weight 70 lbs. Packed in original crate.
YOUR SPECIAL PRICE..... \$7.90

A.C. Phonograph Motor

SYNCHRONOUS—revolves EXACTLY 80 turns per minute despite any voltage variations. Most compact made—only 1 1/2 in. thick—mounts in any limited space. For 110 volt, 60 cycle, A.C. Complete with turntable. Shipping weight 10 lbs. List Price \$15.00.
YOUR SPECIAL PRICE..... \$4.45



Patent "Phonovox" Pick-up

One of the best and most powerful electric phonograph pick-ups made. Balanced tone arm. Unusually sensitive.
YOUR PRICE..... \$4.95

Stewart-Warner Magnetic Chassis



New 1930 Self-Baffled Diphonic Type. Do not confuse with earlier and cheaper models. An ultra-sensitive, loud speaker. Produced by one of radio's greatest companies. Extremely sensitive, tremendous volume without distortion or rattling. Reproduces with absolute fidelity. Speaker uses a power action unit avoiding chattering even under unusual volume. Over-size magnet. We guarantee satisfaction. Cone diameter 9 in. In factory sealed carton. Shipping weight 6 lbs. List Price \$10.00.
OUR PRICE..... \$2.75

R.C.A. Filter Condenser and Output Choke No. 8346

This unit has 7 condensers and an output choke. Condenser values include four 0.5-mfs. capacities and three 2-mfs. capacities—total 8-mfs. Used in Radiola No. 60. Size 6 x 4 x 3 inches. Shipping weight 5 lbs. List Price \$16.50.
YOUR SPECIAL PRICE..... \$5.75



R.C.A. Filter Condenser No. 8289

This condenser unit of 6 condensers includes two 1.0-mfs., two 3.5-mfs., a 2-mf. and a 3-mf. condenser—total capacity 14-mfs. Used in Radiola No. 17 and Radiola No. 50. Size 6 x 4 x 3 inches. Shipping weight 4 1/2 lbs. List Price \$19.20.
YOUR SPECIAL PRICE..... \$5.75

Webster Push-Pull Power Amplifier and "B" Supply



Uses two 226, two 210 and one 281 tubes! Super powerful PUSH-PULL amplifier. GIVES AUDITORIUM VOLUME! Also furnishes 110 volt D.C. speaker field voltage (A.C. speakers can also be used) and 45, 67, 90, 135 volts "B" current. FOR USE AS PHONOGRAPH, SPEECH AND RADIO TUNER AMPLIFIER! 16 in. long, 10 1/2 in. wide, 6 1/2 in. high. Use 2 1/2-volt A.C. filament transformer shown at left to supply "A" current to tubes in tuner, to which it will be coupled. **FULLY GUARANTEED!** For 110 volt, 60 cycle, A.C. Shipping weight 40 lbs. List Price \$100.00.
YOUR SPECIAL PRICE..... \$20.25

SPECIAL! With Peerless Speaker, Cavalier Model 159 Console

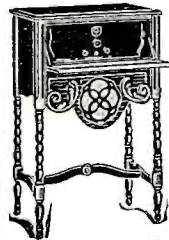

This beautiful and distinctive cabinet is sold with the built-in Peerless Speaker. It is designed to provide a maximum cabinet at a minimum price. Veneers of Figured Walnut with attractive carvings and unusual turnings. Set Compartment, 21 1/4 in. wide x 10 1/2 in. deep x 8 in. high. Height 38 in. Shipping weight 65 lbs. Packed in original crate. Complete with Speaker.
YOUR SPECIAL PRICE..... \$7.95

Earl Power Transformer

Make money revamping the old battery set. This power transformer used in Earl Model 22 receiver supplies "A," "B" and "C" potentials for: two '27's (or screen-grid '24's), three '26's, two '71A's and one '80 rectifier; total current output of high-voltage winding at maximum output (about 200 volts) is 80 ma. High-voltage secondary, filament winding for '27's, and for '71A's are center-tapped. May be used in any number of combinations. Suitable resistors, a couple 4-mf. filter condensers, two 30-henry chokes and by-pass condensers complete fine power pack. Size 3 1/4 x 3 x 2 1/4 inches. 16 long leads and full wiring directions. Shipping weight 5 lbs. List Price \$7.50.
YOUR SPECIAL PRICE..... \$1.75

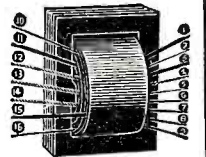

"Marvel" Speaker

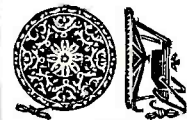

Positively the biggest speaker value in America. You will never again buy a fine speaker for such a ridiculously small amount. 16 in. diameter magnetic speaker with composition artistic polychrome housing. Powerful magnetic unit. Eccentric drive. Beautiful, clear reproduction. NEW feature. Made so speaker can be set on table or hung on wall. Unit fully adjustable. Shipping weight 5 lbs., in factory-sealed carton. List Price \$15.00.
YOUR SPECIAL PRICE..... \$1.75

1/4 H.P. General Electric Motor

This fine 1/4 h.p. induction motor can be used for hundreds of purposes, particularly as a television motor, to run a lathe, household utilities, shop, etc. Single phase, 60 cycle, 110 volts. Uses 5.4 amps. Speed 1,725 r.p.m. Height 6 1/2 in., depth 4 1/2 in., 1/2 in. shaft. No sparking possible. Will therefore not give radio interference. Shipping weight 32 lbs. List Price \$29.00.
YOUR SPECIAL PRICE..... \$9.00

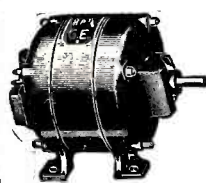

Replacement Power-Pack Condenser Blocks

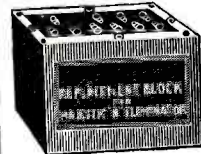

Exact duplicate, physical size, placement of connection terminals, and electrical specifications of original blocks. For Majestic 171 type receivers... **\$5.90**
For Majestic 250 type receivers... **\$5.90**
For Majestic 245 type receivers... **\$5.90**
For Majestic "B" Eliminators... **\$2.90**
The above can be used with any similar power packs—fully guaranteed for ONE YEAR! (All other types can be supplied. Write for prices.)

WE ARE A WHOLESALE HOUSE AND CANNOT ACCEPT ORDERS FOR LESS THAN \$5.00.
If C. O. D. shipment is desired, please remit 20% remittance, which must accompany all orders; balance on delivery.
If the full cash amount accompanies the order, you may deduct 2% discount.

Radio Trading Co.
246 Fifth Avenue
New York, N. Y.

Should you wish goods shipped by parcel post, be sure to include sufficient extra remittance for same. Any excess will be refunded.
We have no catalog but you will find special offers from time to time in this magazine. Prompt shipments will be made.

SERVICE THE BETTER WAY

WITH THE NEW
MODEL 245-A

SET and TUBE TESTER

Readrite

This reliable instrument is now used by thousands of successful service men. Does all necessary field work. Checks all voltages at set socket. Also line voltage. Tests all tubes with speed and accuracy. Illustrated instructions.

Seamless steel case finished in beautiful baked enamel. Built to stand hard field service. Simple to use. Most Compact. Supremely practical.

Your jobber can supply you. If ordered direct, remittance must accompany order.

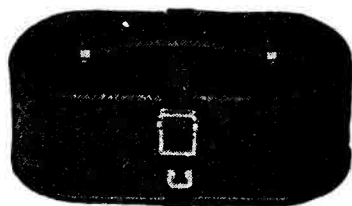

New model equipped with D.C. high resistance plate voltmeter, plate milliammeter and repulsion type A.C. voltmeter.

\$12 NET
\$20 LIST

*Catalog includes Counter Tube Checker, Tool Kit Test Sets,
Ohmmeters, Resistance Meters, Portable and
Panel Meters, Resistors, etc.*

READRITE METER WORKS

Established 1904

17 COLLEGE AVENUE - BLUFFTON, OHIO

FREE RADIO CATALOG

EVERYTHING NEW IN
RADIO

BETTER RADIO

LOWEST
WHOLESALE
PRICES!

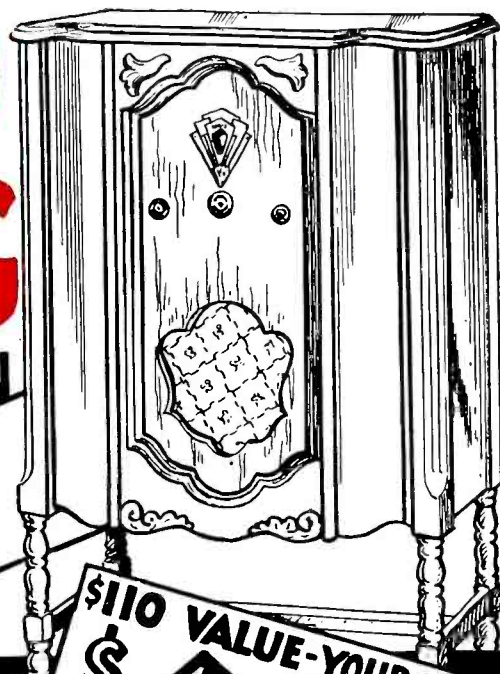

\$110 VALUE-YOUR PRICE

48²⁵



The New Knight Screen Grid Chassis

The circuit of the New Knight 8 Screen Grid is the heir of years of experience in radiomanufacture. Just as it is rich in years of development, so is it replete with an amazing array of advanced features representing the peak achievement in all-electric radio.

8 Tubes—Three Screen Grid

Knight 8 excellence is partially explained by its ingenious circuit which employs three powerful screen grid tubes with an unequalled sensitivity. Two tremendous "245" tubes in push-pull audio arrangement make possible remarkable tone and volume.

New Filtered Tone

Pronounced clarity of tone is the outstanding characteristic of the advanced Knight 8. True life-tone, vibrant and vivid so that you can identify every instrument and every voice, proves that the 1931 Knight loses nothing in reproduction.

Dynamic Speaker Equipped

The power dynamic reproducer is especially designed to match the impedance of the receiver perfectly. It reproduces beautiful tone at any volume, unmarred by any trace of hum or distortion.

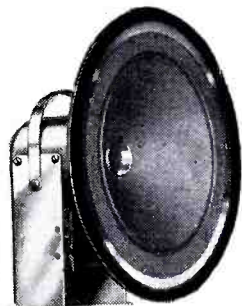

Send For This Catalog Today

OUR NEW "1931" catalog is just off the press—168 pages full of the latest in radio attractions — over 500 illustrations — showing the newest improvements in radio. Prices are lower than ever before. Hundreds of specials are offered at really astounding prices.

Wholesale Prices

Everything in this book is offered at the lowest wholesale prices, which means a tremendous saving to you for anything you want to buy—whether in complete sets—accessories, parts or kits.

All The New Accessories

New 1931 Screen Grid, Tone Control, A. C. Humless All-Electric Sets, Public Address, Phono-Combinations, Dynamic Speakers, Beautiful Consoles. Also battery operated sets.

Wonderful Values

You will be surprised at the remarkable values offered in this book of radio bargains. All the latest features priced to give you remarkable savings.

Tremendous Stocks

The resources of this \$3,000,000 company make it possible for us to buy in large quantities at great savings, and to carry a complete stock of every possible kind of accessory—no matter what you want in radio, we have it.

Use Coupon Below For Free Catalog

Simply sign your name and address to the coupon given below, and mail to us, so as to get this new "1931" book of radio bargains. It is absolutely FREE and we will be glad to send it to you. The prices in it sell themselves.

Slot Machine Sets

Here is the latest machine for bringing in the money automatically for stores, hotels, depots and other public places. A nickel will play it for six minutes.

Phono-Combinations

Screen Grid Radio receiver operates in conjunction with the finest phonograph equipment. A flip of a switch and the radio broadcasts come in through your radio receiver; another flip and the phonograph records may be reproduced electrically.

Electric Clock Sets

Automatic time switch turns radio on and off. Just set for the time your favorite program comes on the air. The set will do the rest.

FREE CATALOG COUPON

Allied Radio Corporation,
711 W. Lake St., Dept. R-1
Chicago

Gentlemen,

Please send me your 168-page FREE radio book of bargains. It is understood there is no obligation for sending this catalog to me, neither will I be bothered by personal calls.

Name _____

Address _____

ALLIED RADIO CORPORATION

711 W. Lake Street Dept. R-1, Chicago

“..... we have adopted
SUPREME SET ANALYZER Model 90
 as standard testing equipment”

R. C. A. INSTITUTES, INC.
 75 BARICK STREET NEW YORK
 September 3, 1930.

Supreme Instruments Corp.
 Greenwood, Miss.

Gentlemen:

After many months careful consideration, test and comparison of the leading set testers, we have officially adopted "Supreme Set Analyzer Model 90" as standard testing equipment of this institution and are placing this instrument with our students as a supplement to our regular course of study.

In making this decision we feel that we are adding to the thorough training our students receive, the best mechanical equipment ever designed and that they will be prepared in a manner that will reflect credit both upon themselves and R. C. A. Institutes.

Almost from its inception we have been using the "Supreme Diagonometers" in connection with the "Supreme Test Panel" in all of our resident schools and it is our acquaintance with this equipment that first gave birth to the confidence in "SUPREME" products that culminated in the adoption of Model 90 as standard equipment for our students.

Permit us to congratulate you upon the superior design and construction of your instruments, which we consider a valuable contribution to radio. With sincere wishes for your continued success, we remain

Sincerely,
 R. C. A. INSTITUTES, INC.

R. L. Duncan

A DIVISION OF RADIO CORPORATION OF AMERICA



MR. R. L. DUNCAN
 Mr. Duncan is President of R. C. A. Institutes, Inc., a member of the Institute of Radio Engineers, Veteran Wireless Operators Association, Captain Sig. R. United States Army and a recognized authority on the theory and practice of radio.

**RADIO'S
 OLDEST
 SCHOOL**

R. C. A. Institutes, Inc., (a division of Radio Corporation of America) is the oldest radio school in existence, having been founded by the Marconi Company in 1909. Signor Guglielmo Marconi, the noted pioneer of radio (wireless) communication, is Honorary Chairman. Graduates of R. C. A. Institutes hold responsible positions in radio throughout the world.

SUPREME
Testing Instruments
 "SUPREME BY COMPARISON"

SUPREME TESTING instruments are the recognized standard in the radio industry; they are in use in practically all educational institutions and their outstanding merit is conceded by leading radio engineers and technicians.



SUPREME SET ANALYZER
 Model 90
 List Price **\$112.15**
 Dealers Net Price **\$78.50**
 f.o.b. Greenwood, Miss.

All leading distributors stock SUPREME TESTING INSTRUMENTS, including the Diagonometer, Coaxial Tappet Checker, and Chrometer, in addition to Supreme Set Analyzers. If yours cannot give you full information, see coupon to right.

SUPREME INSTRUMENTS CORP.
 GREENWOOD, MISSISSIPPI

Distributors in all Principal Cities
 Service Depots in New York, Philadelphia, Pittsburgh, Chicago, Kansas City, Seattle, San Francisco, Toronto

EXPORT DIVISION 110 West 42nd ST., NEW YORK CITY CABLE ADDRESS, LOPREH

SUPREME INSTRUMENTS CORP.
 382 Supreme Bldg., Greenwood, Miss.

Please give full information on _____

(Specify Supreme Product interested in)

Signed _____

Firm Name _____

Street Address _____

Town _____ State _____